

NOTES:

1. SUBSTRATE MATERIAL:
FUSED SILICA

2. COATING (APPLY ACROSS CLEAR APERTURE)

S1: R(abs)= 30% ±5% @ 350nm
R(avg)= 30% ±10% OVER 250 - 450nm
T(abs)= 70% ±5% @ 350nm
T(avg)= 70% ±10% OVER 250 - 450nm

S2: BBAR (R(avg) <1%, R(abs) <2% OVER 250 - 450nm)

3. EDGES FINE GROUND

4. ROHS COMPLIANT

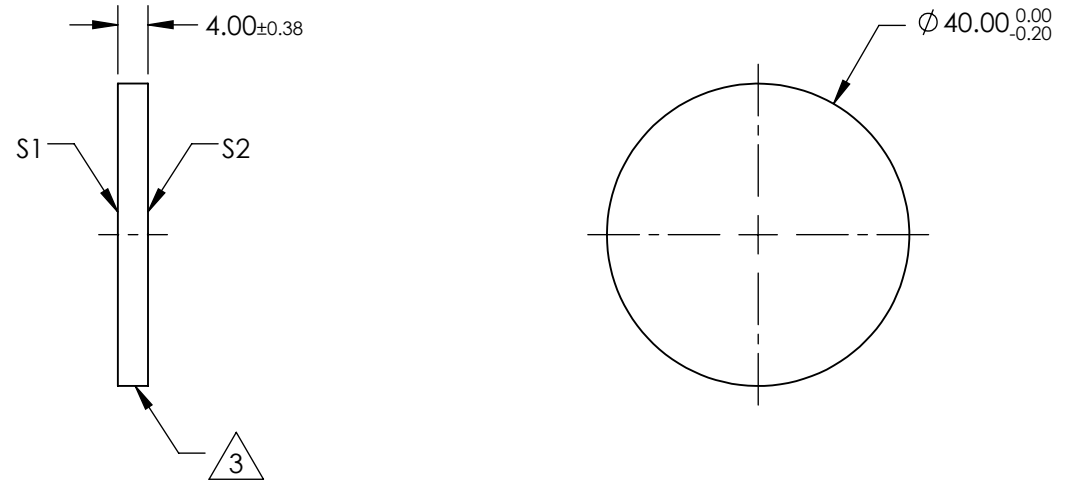

**FOR INFORMATION ONLY:
DO NOT MANUFACTURE
PARTS TO THIS DRAWING**

SPECIFICATIONS SUBJECT TO CHANGE WITHOUT NOTICE
DIMENSIONS ARE FOR REFERENCE ONLY

REV. A	S1	S2
SHAPE	PLANO	PLANO
CLEAR APERTURE	Ø34.00	Ø34.00
SURFACE QUALITY	60-40	60-40
SURFACE FLATNESS	1λ	1λ
BEVEL	PROTECTED AS NEEDED	PROTECTED AS NEEDED

THIRD ANGLE PROJECTION

ALL DIMS IN

mm

EO® Edmund Optics®

TITLE

Ø40mm, 30R/70T, UV PLATE BEAMSPLITTER

DWG NO

65928

SHEET
1 OF 1