

**FOR INFORMATION ONLY:
DO NOT MANUFACTURE
PARTS TO THIS DRAWING**

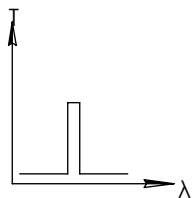
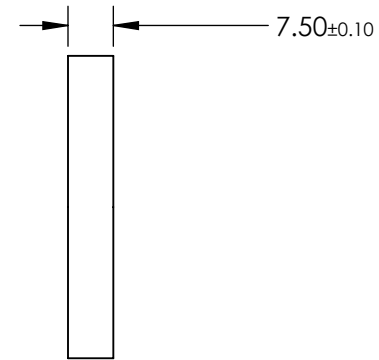
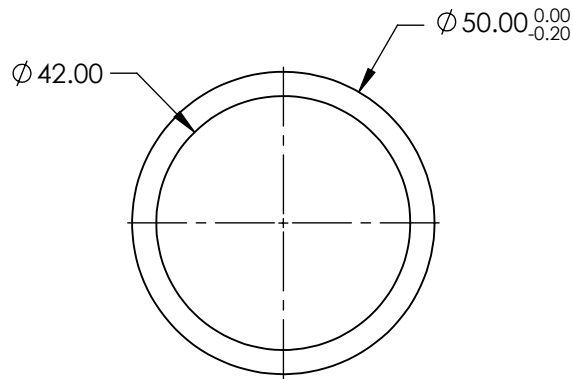
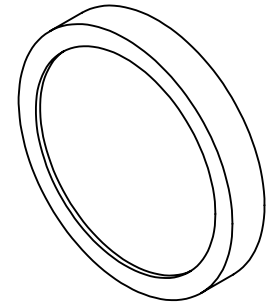

BANDPASS FILTER

	VALUE
OPTICAL DENSITY	≥3.0
CENTER WAVELENGTH (CWL)	852 ±2 nm
FULL WIDTH HALF MAX (FWHM)	10 ±2 nm
MINIMUM TRANSMISSION	≥50 %
BLOCKING	200 - 1200nm
SURFACE QUALITY	80-50
CONSTRUCTION	MOUNTED IN BLACK ANODIZED RING
COATING TYPE	TRADITIONAL COATED

SPECIFICATIONS SUBJECT TO CHANGE WITHOUT NOTICE
DIMENSIONS ARE FOR REFERENCE ONLY



ALL DIMS IN

mm

TITLE

Ø50mm, 852nm x 10nm, MOUNTED
BANDPASS FILTER

DWG NO

86638

SHEET
1 OF 1