

**FOR INFORMATION ONLY:
DO NOT MANUFACTURE
PARTS TO THIS DRAWING**

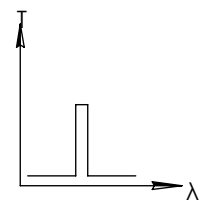
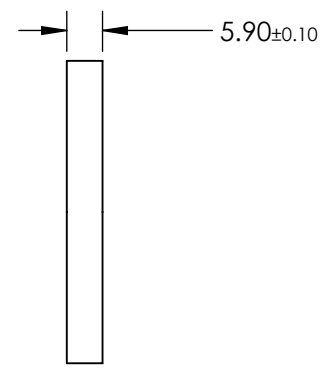
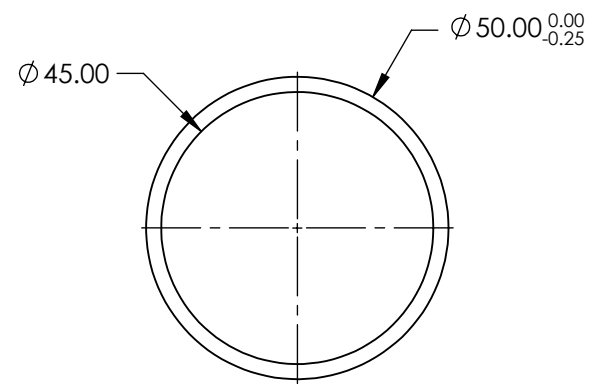
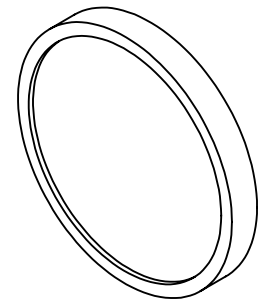

BANDPASS FILTER

SPECIFICATIONS SUBJECT TO CHANGE WITHOUT NOTICE
DIMENSIONS ARE FOR REFERENCE ONLY

	VALUE
OPTICAL DENSITY	≥4.0
CENTER WAVELENGTH (CWL)	810 +3.0/-0.0 nm
FULL WIDTH HALF MAX (FWHM)	10 ±2 nm
MINIMUM TRANSMISSION	>50 %
BLOCKING	200 - Far IR
SURFACE QUALITY	80-50
CONSTRUCTION	MOUNTED IN BLACK ANODIZED RING
COATING TYPE	TRADITIONAL COATED



THIRD ANGLE PROJECTION		TITLE	Ø50mm, 810nm x 10nm, MOUNTED BANDPASS FILTER	
ALL DIMS IN	mm	DWG NO	67916	SHEET 1 OF 1