

**FOR INFORMATION ONLY:  
DO NOT MANUFACTURE  
PARTS TO THIS DRAWING**

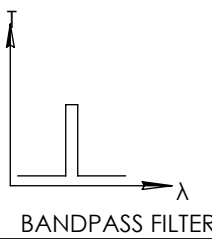

	VALUE
OPTICAL DENSITY	$\geq 3.0$
CENTER WAVELENGTH (CWL)	$508 \pm 2 \text{ nm}$
FULL WIDTH HALF MAX (FWHM)	$10 \pm 2 \text{ nm}$
MINIMUM TRANSMISSION	$\geq 45 \%$
BLOCKING	200 - 1200nm
SURFACE QUALITY	80-50
CONSTRUCTION	MOUNTED IN BLACK ANODIZED RING
COATING TYPE	TRADITIONAL COATED

SPECIFICATIONS SUBJECT TO CHANGE WITHOUT NOTICE  
DIMENSIONS ARE FOR REFERENCE ONLY

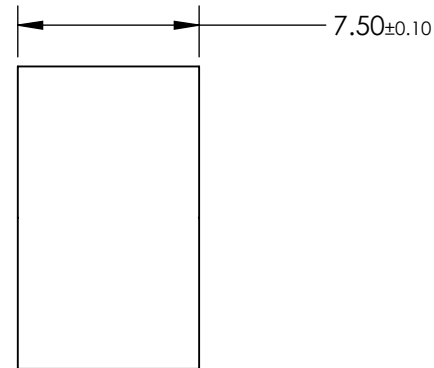
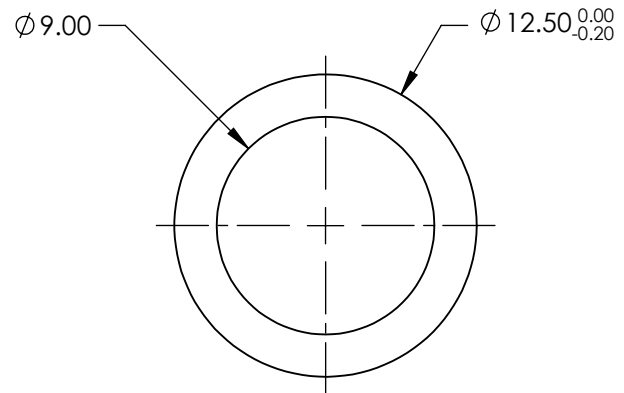
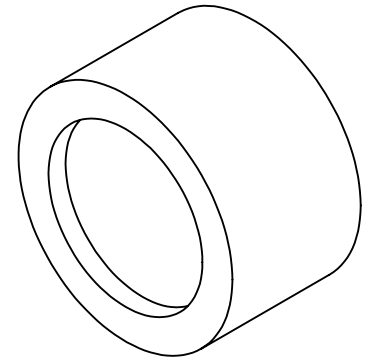

THIRD ANGLE PROJECTION 	TITLE	$\phi 12.5\text{mm}$ , 508nm x 10nm, MOUNTED BANDPASS FILTER	
ALL DIMS IN	mm	DWG NO	65636
			SHEET 1 OF 1