

**FOR INFORMATION ONLY:  
DO NOT MANUFACTURE  
PARTS TO THIS DRAWING**

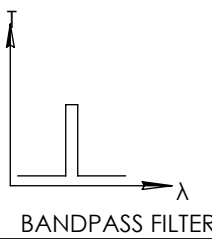

	VALUE
OPTICAL DENSITY	$\geq 3.0$
CENTER WAVELENGTH (CWL)	$500 \pm 2$ nm
FULL WIDTH HALF MAX (FWHM)	$10 \pm 2$ nm
MINIMUM TRANSMISSION	$\geq 45$ %
BLOCKING	200 - 1200nm
SURFACE QUALITY	80-50
CONSTRUCTION	MOUNTED IN BLACK ANODIZED RING
COATING TYPE	TRADITIONAL COATED

SPECIFICATIONS SUBJECT TO CHANGE WITHOUT NOTICE  
DIMENSIONS ARE FOR REFERENCE ONLY

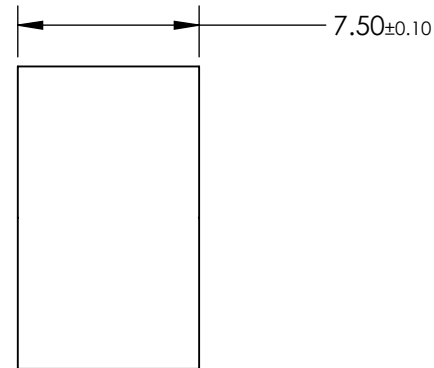
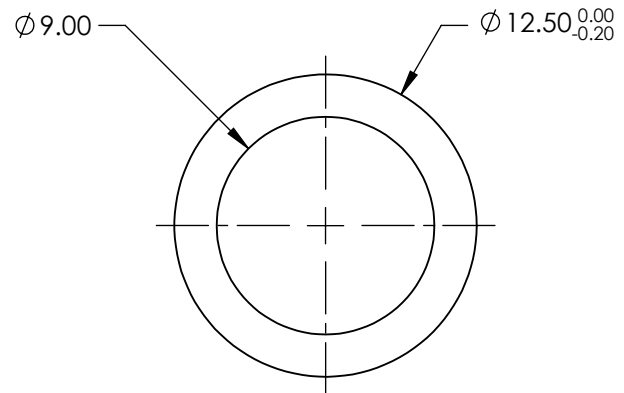
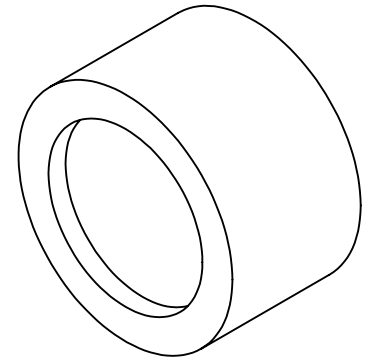

THIRD ANGLE PROJECTION		TITLE	$\phi 12.5$ mm, 500nm x 10nm, MOUNTED BANDPASS FILTER
ALL DIMS IN	mm	DWG NO	65634
			SHEET 1 OF 1