

NOTES:

1. SUBSTRATE:  
N-BK7
2. INCIDENT AND REFLECTED BEAMS SHALL BE PARALLEL TO WITHIN 3 ARCSEC
3. COATING (APPLY ACROSS COATING APERTURE)  
S1: PROTECTED SILVER  
R(AVG) >98% @ 500 - 800nm  
R(AVG) >98% @ 2 - 10 μm W/BLACK OVERPAINT  
S2: NONE

4. FINE GRIND SURFACE

5. ROHS: COMPLIANT

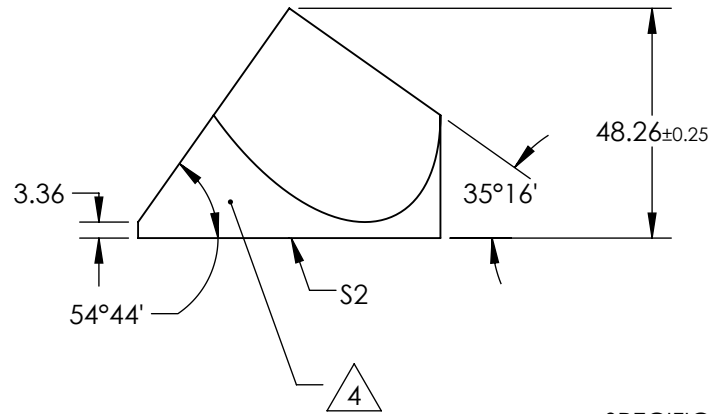
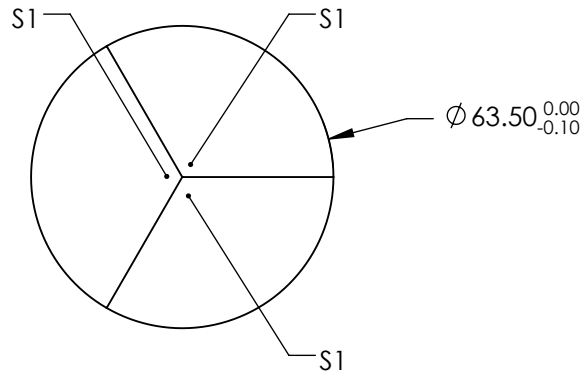
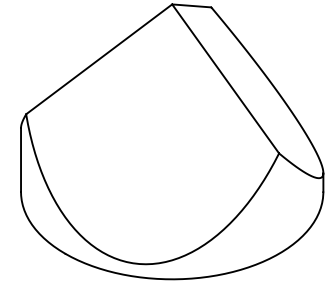

**FOR INFORMATION ONLY:  
DO NOT MANUFACTURE  
PARTS TO THIS DRAWING**

SPECIFICATIONS SUBJECT TO CHANGE WITHOUT NOTICE  
DIMENSIONS ARE FOR REFERENCE ONLY

REV A	S1 & S2
SURFACE FLATNESS	$\lambda/8$
SURFACE QUALITY	60-40
WAVELENGTH RANGE	400 - 2200 nm
BEVEL	PROTECTED AS NEEDED

THIRD ANGLE PROJECTION

ALL DIMS IN mm

**EO**® Edmund Optics®

TITLE

63.5mm SILVER COATED, CORNER CUBE PRISM

DWG NO

48593

SHEET 1 OF 1