

NOTES:

1. SUBSTRATE:  
KBR
2. COATING (APPLY ACROSS CLEAR APERTURE)  
S1 & S2: NONE
3. FINE GRIND SURFACE
4. RoHS COMPLIANT

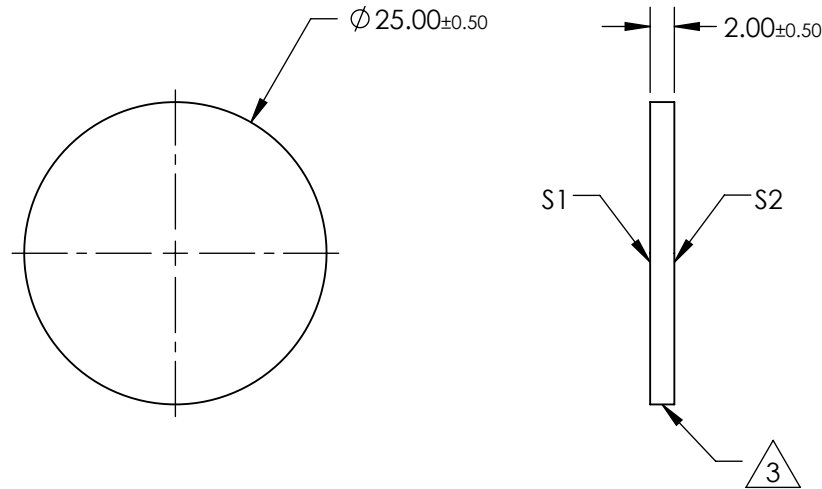
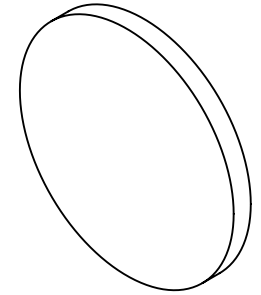

**FOR INFORMATION ONLY:  
DO NOT MANUFACTURE  
PARTS TO THIS DRAWING**

SPECIFICATIONS SUBJECT TO CHANGE WITHOUT NOTICE  
DIMENSIONS ARE FOR REFERENCE ONLY

**EO**® Edmund Optics®

	S1	S2	THIRD ANGLE PROJECTION		TITLE	Ø25mm x 2mm THICKNESS, UNCOATED, POTASSIUM BROMIDE WINDOW	
SHAPE	PLANO	PLANO	ALL DIMS IN	mm	DWG NO	68807	SHEET 1 OF 1
SURFACE QUALITY	80-50	80-50					
BEVEL	PROTECTIVE AS NEEDED	PROTECTIVE AS NEEDED					