

NOTES:

1. SUBSTRATE:  
VACUUM UV GRADE CAF<sup>2</sup>
2. SURFACE S2 TO BE PARALLEL WITH S1 TO <1 arcmin
3. COATING (APPLY ACROSS CLEAR APERTURE)  
S1 & S2: NONE

 4. FINE GRIND SURFACE

5. RoHS EXEMPT

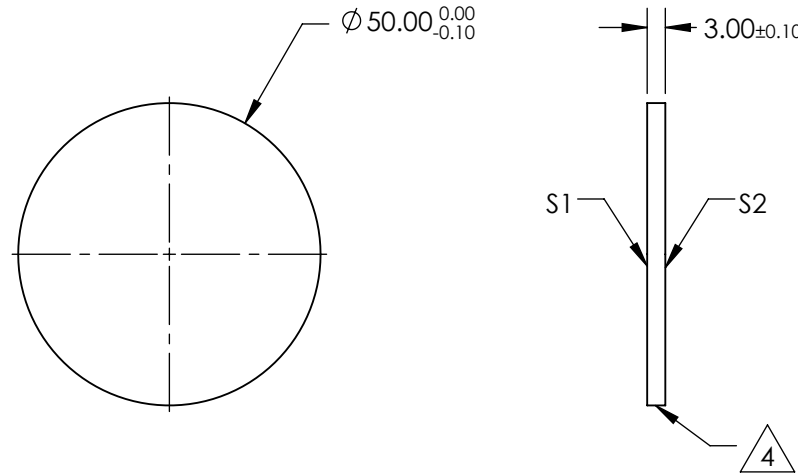
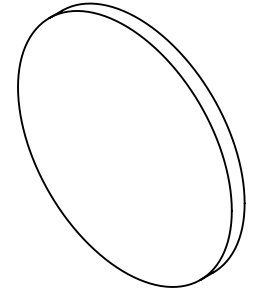

**FOR INFORMATION ONLY:  
DO NOT MANUFACTURE  
PARTS TO THIS DRAWING**

SPECIFICATIONS SUBJECT TO CHANGE WITHOUT NOTICE  
DIMENSIONS ARE FOR REFERENCE ONLY

	S1	S2
SHAPE	PLANO	PLANO
SURFACE QUALITY	40-20	40-20
CLEAR APERTURE	90%	90%
BEVEL	PROTECTIVE AS NEEDED	PROTECTIVE AS NEEDED

THIRD ANGLE PROJECTION 

ALL DIMS IN mm

 **Edmund Optics®**

TITLE

Ø50mm, UNCOATED, CALCIUM FLUORIDE WINDOW

DWG NO

47684

SHEET  
1 OF 1