

DETAIL B

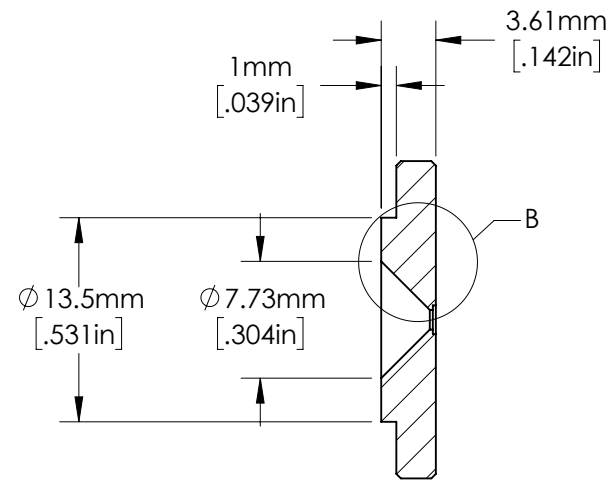
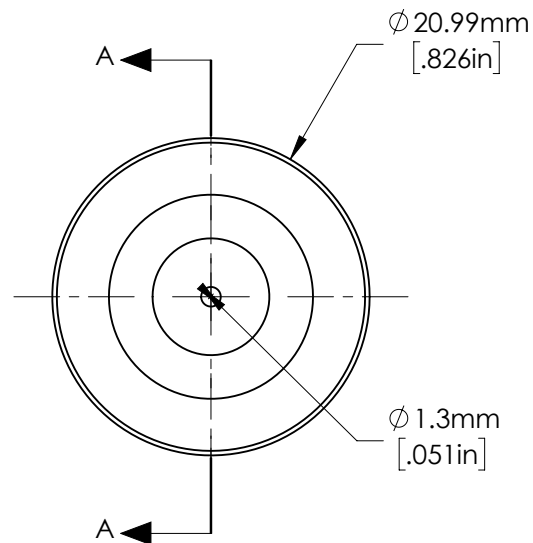

SECTION A-A

SPECIFICATIONS SUBJECT TO CHANGE WITHOUT NOTICE
DIMENSIONS ARE FOR REFERENCE ONLY

FOR INFORMATION ONLY:
DO NOT MANUFACTURE
PARTS TO THIS DRAWING

 **Edmund Optics®**

TITLE	F11.0 APERTURE FOR 16mm Cx LENS	
DWG NO	33643	SHEET 1 OF 1