

**FOR INFORMATION ONLY:
DO NOT MANUFACTURE
PARTS TO THIS DRAWING**

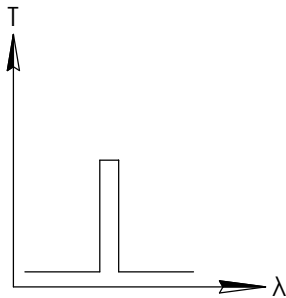
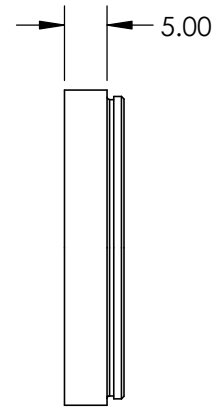
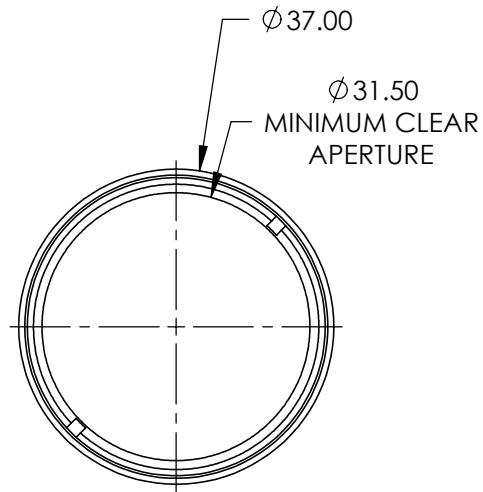
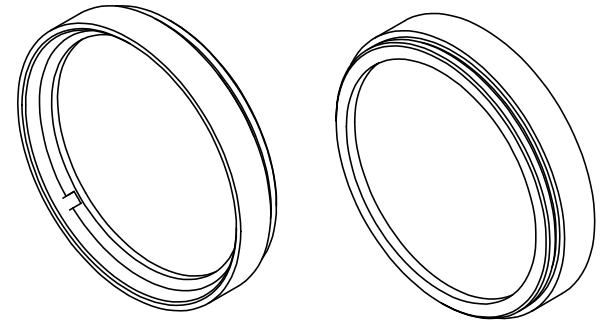

IMAGING FILTER

REV. A	VALUE
CENTER WAVELENGTH (CWL)	634 ± 2nm
FULL WIDTH HALF MAX (FWHM)	70 ± 2nm
MINIMUM TRANSMISSION	93 AVG
BLOCKING	200 - 1200
SURFACE QUALITY	80-50
CONSTRUCTION	MOUNTED IN BLACK ANODIZED ALUMINUM RING
COATING TYPE	HARD COATED
DURABILITY	MIL-C-48497A, SECT. 3.4.1
ENVIRONMENTAL	MIL-STD-801F, SECT. 507.4

SPECIFICATIONS SUBJECT TO CHANGE WITHOUT NOTICE
DIMENSIONS ARE FOR REFERENCE ONLY



ALL DIMS IN

mm

TITLE

LIGHT RED M35.5 X 0.50 IMAGING FILTER

DWG NO

89817

SHEET
1 OF 1