

NOTES:

1. CONSTRUCTION: MOUNTED IN BLACK ANODIZED RING
2. COATING (APPLY ACROSS COATING APERTURE)

DURABILITY: MIL-C-48497A  
 PERFORMANCE SPECIFICATIONS:  
 CWL: 1064nm  
 FWHM: 73nm

R (ABS) > 99.5% @ 1064±10.6nm  
 T (ABS) < 0.001% @ 1064±10.6nm  
 T (AVG) ≥ 80% FROM 350 - 400nm  
 T (AVG) ≥ 90% FROM 400 - 1200nm

3. SURFACE QUALITY: 60-40
4. TRANSMITTED WAVEFRONT DISTORTION RMS @632.8nm: <math>1\lambda</math>
5. ROHS COMPLIANT

 ARROW ON PART POINTS TOWARDS COATED SURFACE

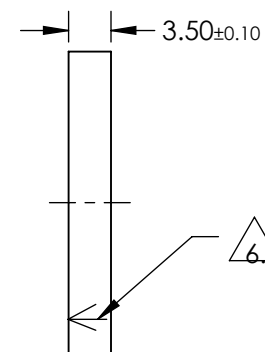
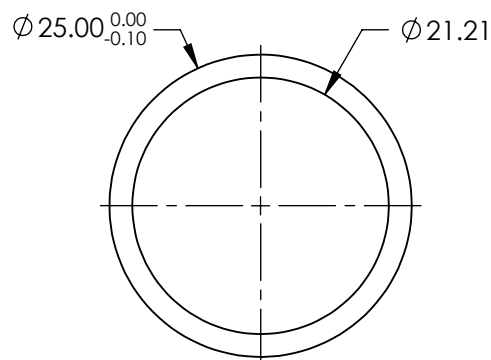
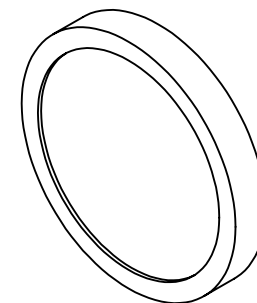

**FOR INFORMATION ONLY:  
 DO NOT MANUFACTURE  
 PARTS TO THIS DRAWING**

SPECIFICATIONS SUBJECT TO CHANGE WITHOUT NOTICE  
 DIMENSIONS ARE FOR REFERENCE ONLY

 **Edmund Optics®**

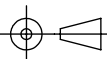
THIRD ANGLE PROJECTION 		TITLE	OD6, Ø25mm, 1064nm, BLOCKING NOTCH FILTER	
ALL DIMS IN	mm	DWG NO	86128	SHEET 1 OF 1