

NOTES:

**FOR INFORMATION ONLY:
DO NOT MANUFACTURE
PARTS TO THIS DRAWING**

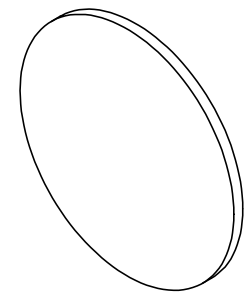

1. SUBSTRATE
 2. SURFACE S2 TO BE PARALLEL WITH SURFACE S1 TO WITHIN 5 arcsec
 3. COATING (APPLY ACROSS COATING APERTURE)
ENVIRONMENTAL DURABILITY:
PHYSICAL DURABILITY:
PERFORMANCE SPECIFICATIONS:
T(avg): >85% FROM 400 - 725nm FOR RANDOM POLARIZATION @ 45° AOI
T(abs): >80% FROM 400 - 725nm FOR ALL POLARIZATIONS @ 45° AOI
R(avg): >97% FROM 800 - 990nm FOR RANDOM POLARIZATION @ 45° AOI
R(abs): >95% FROM 800 - 990nm FOR ALL POLARIZATIONS @ 45° AOI
T(abs): = 50% 750nm @ 45° AOI
- S1: HARD COATED
S2: SINGLE LAYER MgF2

 FINE GRIND SURFACE

5. POWER, IRREGULARITY, AND SURFACE QUALITY SPECIFICATIONS
APPLY ACROSS CLEAR APERTURE
6. TRANSMITTED WAVEFRONT DISTORTION RMS@ 632.8nm $\leq \frac{1}{4} \lambda$
7. ROHS COMPLIANT

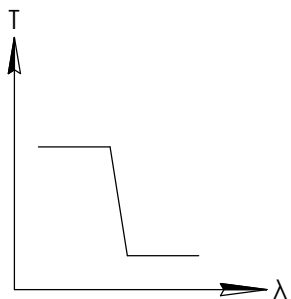
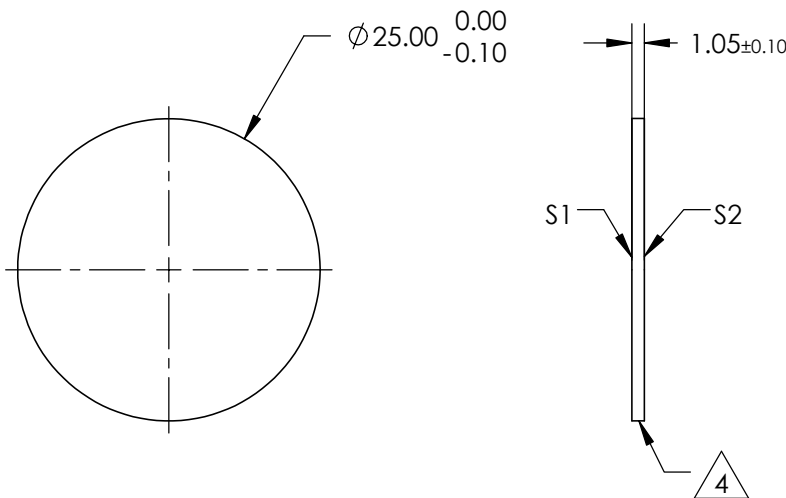

SHORTPASS FILTER

SPECIFICATIONS SUBJECT TO CHANGE WITHOUT NOTICE
DIMENSIONS ARE FOR REFERENCE ONLY

	S1	S2
SHAPE	PLANO	PLANO
SURFACE QUALITY	40-20	40-20
CLEAR APERTURE	$\varnothing 22.00$	$\varnothing 22.00$
COATING APERTURE	$\varnothing 24.00$	$\varnothing 24.00$
BEVEL	PROTECTIVE AS NEEDED	PROTECTIVE AS NEEDED

 **Edmund Optics®**

THIRD ANGLE
PROJECTION

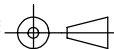

TITLE

$\varnothing 25\text{mm}$, 750nm DICHROIC SHORTPASS FILTER

DWG NO

69207

ALL DIMS IN

mm

SHEET
1 OF 1