

NOTES:

1. CONSTRUCTION: MOUNTED IN BLACK ANODIZED RING
2. COATING (APPLY ACROSS COATING APERTURE)

DURABILITY: MIL-C-48497A  
 PERFORMANCE SPECIFICATIONS:  
 CWL: 1064nm  
 FWHM: 53.2nm ± 5.3nm

R (ABS) > 99% @ 1064±10.6nm  
 T (ABS) < 0.01% @ 1064±10.6nm  
 T (AVG) > 90% FROM 800 - 1032.1nm  
 T (AVG) > 90% FROM 1095.9 - 1400nm

3. SURFACE QUALITY: 60-40
4. TRANSMITTED WAVEFRONT DISTORTION RMS @632.8nm: <1λ
5. ROHS COMPLIANT

 ARROW ON PART POINTS TOWARDS COATED SURFACE

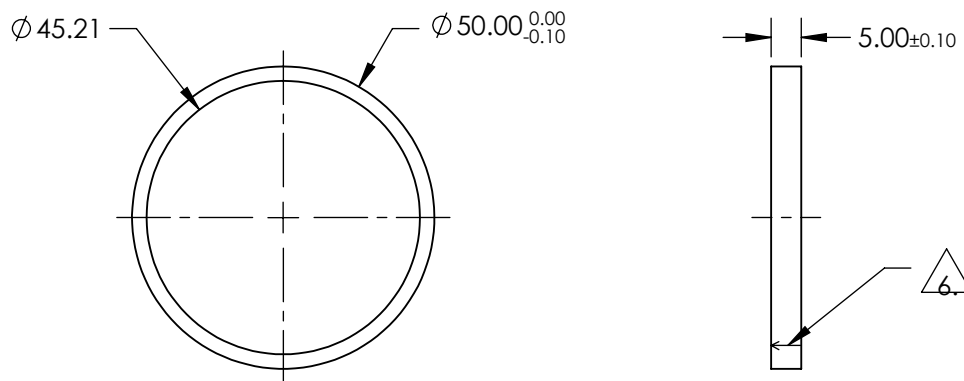
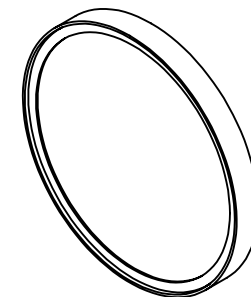

**FOR INFORMATION ONLY:  
 DO NOT MANUFACTURE  
 PARTS TO THIS DRAWING**

SPECIFICATIONS SUBJECT TO CHANGE WITHOUT NOTICE  
 DIMENSIONS ARE FOR REFERENCE ONLY

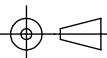

THIRD ANGLE PROJECTION 		TITLE	OD4, Ø50mm, 1064nm, NOTCH FILTER	
ALL DIMS IN	mm	DWG NO	67132	SHEET 1 OF 1