

NOTES:

1. CONSTRUCTION: MOUNTED IN BLACK ANODIZED RING
2. COATING (APPLY ACROSS COATING APERTURE)

DURABILITY: MIL-C-48497A
 PERFORMANCE SPECIFICATIONS:
 CWL: 488nm
 FWHM: 24.4nm ± 2.4nm

R (ABS) > 99% @ 488±4.9nm
 T (ABS) < 0.01% @ 488±4.9nm
 T (AVG) > 90% FROM 365 - 473.4nm
 T (AVG) > 90% FROM 502.6 - 650nm

3. SURFACE QUALITY: 60-40
4. TRANSMITTED WAVEFRONT DISTORTION RMS @632.8nm: <1λ
5. ROHS COMPLIANT

 ARROW ON PART POINTS TOWARDS COATED SURFACE

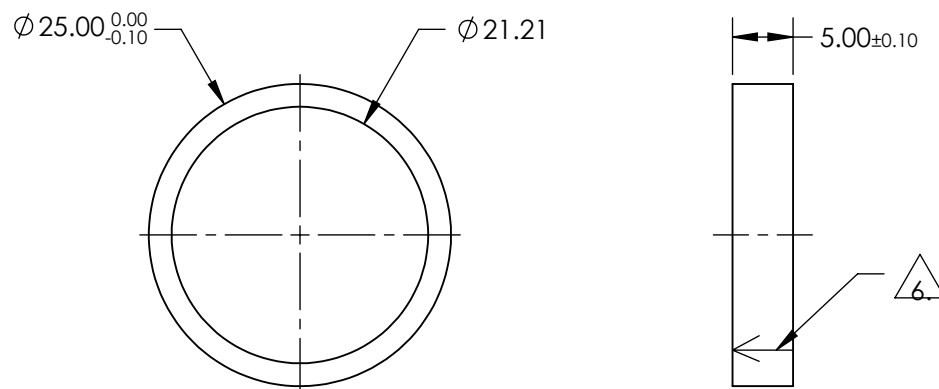
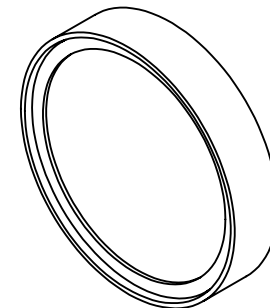

**FOR INFORMATION ONLY:
 DO NOT MANUFACTURE
 PARTS TO THIS DRAWING**

SPECIFICATIONS SUBJECT TO CHANGE WITHOUT NOTICE
 DIMENSIONS ARE FOR REFERENCE ONLY

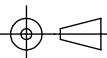

THIRD ANGLE PROJECTION 		TITLE	OD4, Ø25mm, 488nm, NOTCH FILTER	
ALL DIMS IN	mm	DWG NO	67117	SHEET 1 OF 1