

NOTES:

1. SUBSTRATE:
FUSED SILICA MOUNTED IN BLACK ANODIZED ALUMINUM RING
2. TRANSMITTED WAVEFRONT ERROR: $\lambda/4$
3. RoHS: COMPLIANT

**FOR INFORMATION ONLY:
DO NOT MANUFACTURE
PARTS TO THIS DRAWING**

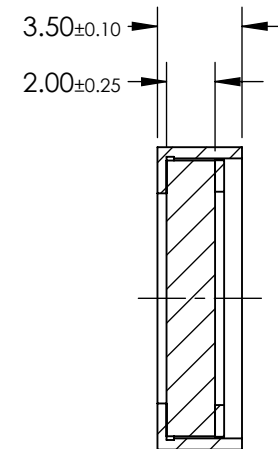
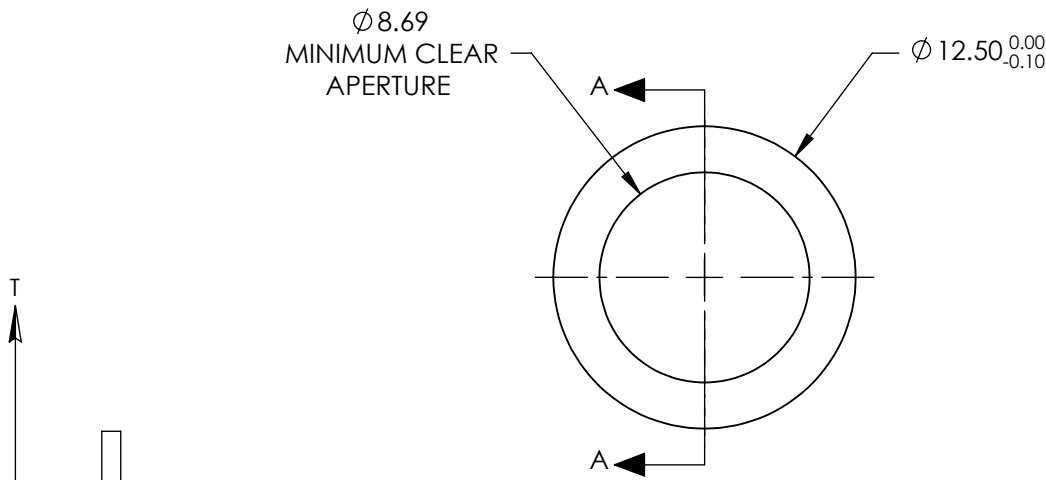

SECTION A-A

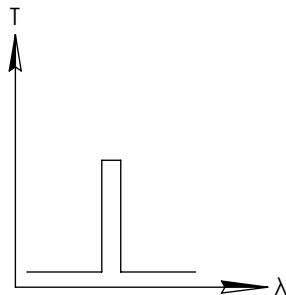

BANDPASS FILTER

	VALUE
CENTER WAVELENGTH (CWL) (nm)	438 ± 3
MINIMUM BANDPATH (nm)	24
FULL WIDTH HALF MAX (FWHM) (nm)	28
MINIMUM TRANSMISSION (%)	>93
OD6 BLOCKING RANGE (nm)	250 - 415 & 460 - 600
SURFACE QUALITY	60-40
COATING TYPE	HARD COATED
DURABILITY	MIL-C-48497A, SECT. 3.4.1
ENVIRONMENTAL	MIL-STD-801F, SECT. 507 .4

SPECIFICATIONS SUBJECT TO CHANGE WITHOUT NOTICE
DIMENSIONS ARE FOR REFERENCE ONLY

EO® **Edmund Optics**®

THIRD ANGLE PROJECTION

TITLE OD6, Ø12.5mm, 438nm x 24nm, BP
FLUORESCENCE FILTER

ALL DIMS IN

mm

DWG NO

67012

SHEET
1 OF 1