

NOTES:

1. SUBSTRATE: UV FUSED SILICA
2. SURFACE S2 TO BE PARALLEL WITH SURFACE S1 TO WITHIN 5 arcsec
3. COATING (APPLY ACROSS COATING APERTURE)
 S1: HARD DIELECTRIC SPUTTERED
 T(avg): $\geq 91\%$ FROM 765 - 1650nm @ 0° AOI
 T(avg): $\leq 0.01\%$ FROM 200 - 735nm @ 0° AOI
 T(abs): =50% FOR 750 \pm 7.5nm @ 0° AOI
 S2: SINGLE LAYER MgF2

4. FINE GRIND SURFACE

5. POWER, IRREGULARITY, AND SURFACE QUALITY SPECIFICATIONS APPLY ACROSS CLEAR APERTURE
6. TRANSMITTED WAVEFRONT DISTORTION, RMS: $\leq \lambda/4$ @ 633nm
7. ROHS COMPLIANT

**FOR INFORMATION ONLY:
DO NOT MANUFACTURE
PARTS TO THIS DRAWING**

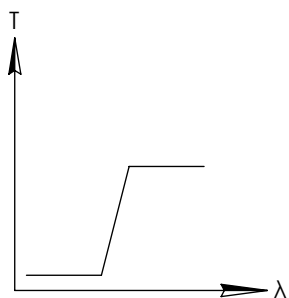
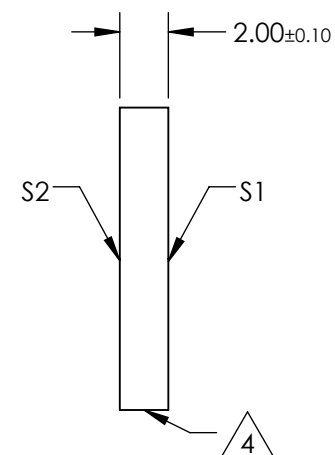
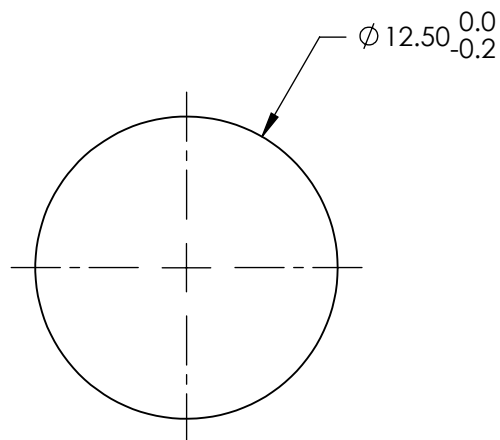
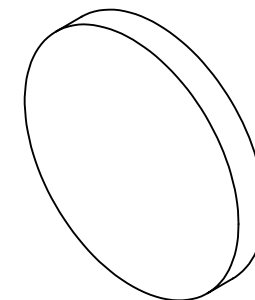

LONGPASS FILTER

SPECIFICATIONS SUBJECT TO CHANGE WITHOUT NOTICE
DIMENSIONS ARE FOR REFERENCE ONLY

	S1	S2
SHAPE	PLANO	PLANO
SURFACE QUALITY	60-40	60-40
CLEAR APERTURE	>80%	>80%
BEVEL	PROTECTIVE AS NEEDED	PROTECTIVE AS NEEDED

EO® Edmund Optics®

THIRD ANGLE PROJECTION

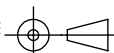

TITLE

Ø12.5mm, 750nm, HIGH PERFORMANCE
LONGPASS FILTER

ALL DIMS IN

mm

DWG NO

66226

SHEET
1 OF 1