

**FOR INFORMATION ONLY:  
DO NOT MANUFACTURE  
PARTS TO THIS DRAWING**

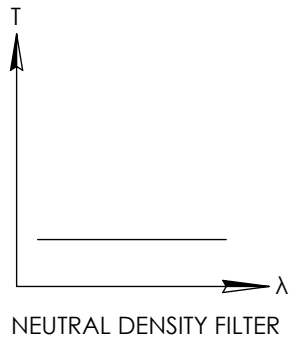
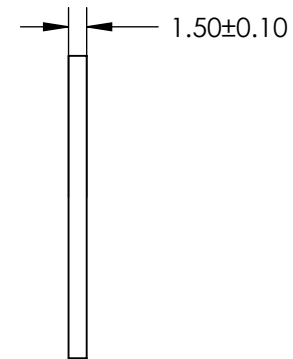
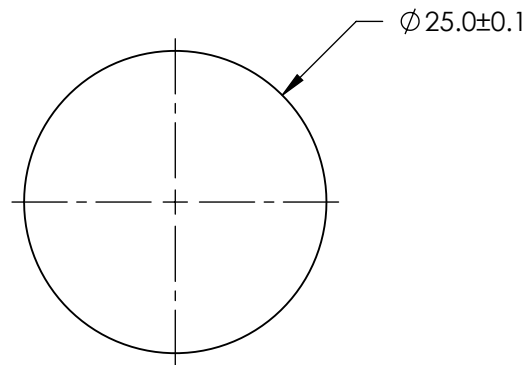
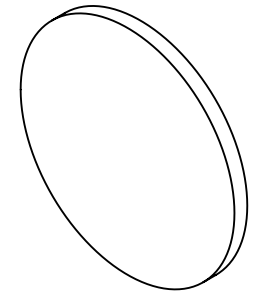
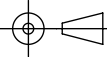

SPECIFICATIONS SUBJECT TO CHANGE WITHOUT NOTICE  
DIMENSIONS ARE FOR REFERENCE ONLY

**EO**<sup>®</sup> **Edmund Optics**<sup>®</sup>

THIRD ANGLE PROJECTION 		TITLE	OD 2, Ø25mm NIR, NON-REFLECTIVE ND FILTER	
ALL DIMS IN	mm	DWG NO	63413	SHEET 1 OF 1