

**FOR INFORMATION ONLY:
DO NOT MANUFACTURE
PARTS TO THIS DRAWING**

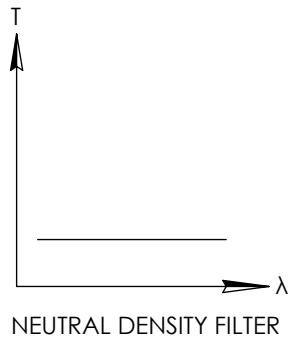
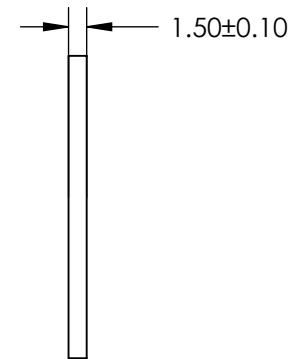
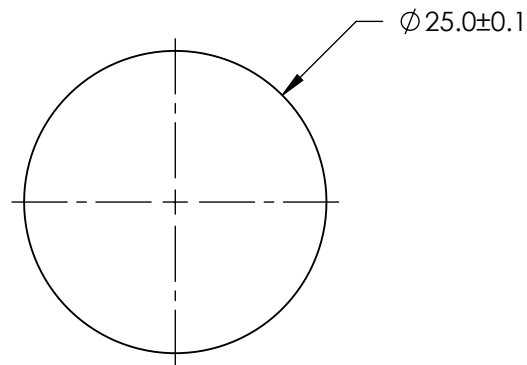
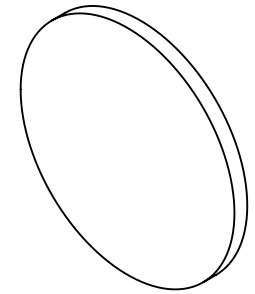

SPECIFICATIONS SUBJECT TO CHANGE WITHOUT NOTICE
DIMENSIONS ARE FOR REFERENCE ONLY

EO[®] **Edmund Optics**[®]

THIRD ANGLE PROJECTION		TITLE	OD 1.5, Ø25mm NIR, NON-REFLECTIVE ND FILTER	
ALL DIMS IN	mm	DWG NO	63392	SHEET 1 OF 1