

**FOR INFORMATION ONLY:
DO NOT MANUFACTURE
PARTS TO THIS DRAWING**

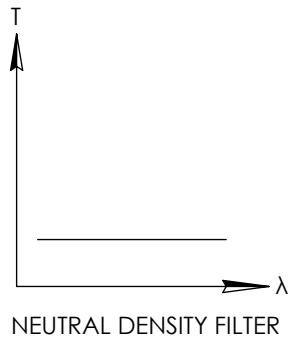
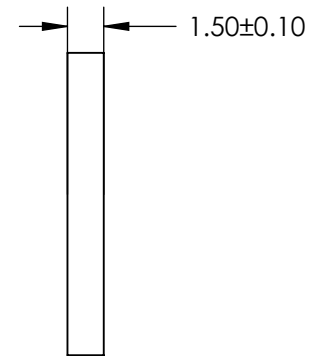
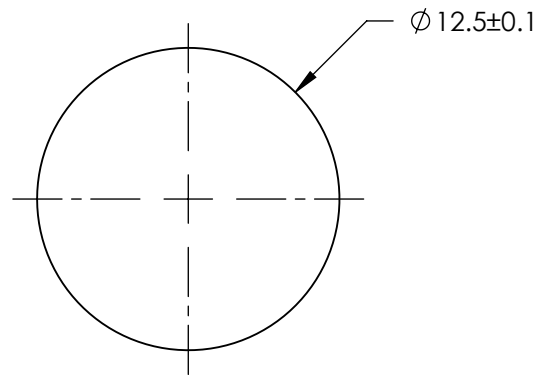
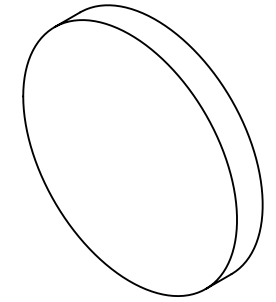
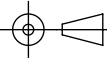

SPECIFICATIONS SUBJECT TO CHANGE WITHOUT NOTICE
DIMENSIONS ARE FOR REFERENCE ONLY

EO[®] **Edmund Optics**[®]

THIRD ANGLE PROJECTION 		TITLE	OD 3, Ø12.5mm NIR, NON-REFLECTIVE ND FILTER	
ALL DIMS IN	mm	DWG NO	63385	SHEET 1 OF 1