

NOTES:

1. SUBSTRATE: FUSED SILICA
2. SURFACE S2 TO BE PARALLEL WITH SURFACE S1 TO WITHIN 5 arcsec
3. COATING (APPLY ACROSS COATING APERTURE)
 S1: METALLIC N.D., OPTICAL DENSITY (abs) = 2 FROM 700 - 1100nm
 S2: NONE

4.  FINE GRIND SURFACE

5. POWER, IRREGULARITY, AND SURFACE QUALITY SPECIFICATIONS
 APPLY ACROSS CLEAR APERTURE
6. TRANSMITTED WAVEFRONT DISTORTION P-V @ 632.8nm: $\leq 0.1 \lambda$
7. ROHS COMPLIANT

**FOR INFORMATION ONLY:
DO NOT MANUFACTURE
PARTS TO THIS DRAWING**

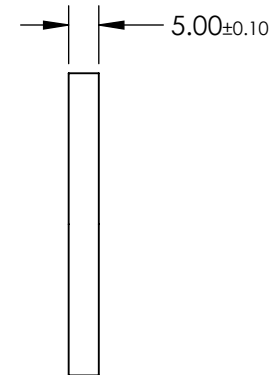
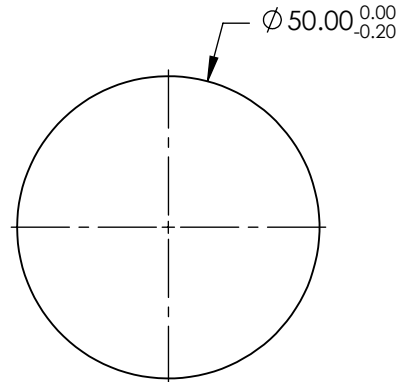
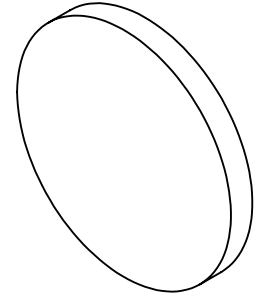

SPECIFICATIONS SUBJECT TO CHANGE WITHOUT NOTICE
 DIMENSIONS ARE FOR REFERENCE ONLY

	S1	S2
SHAPE	PLANO	PLANO
SURFACE QUALITY	40-20	40-20
CLEAR APERTURE	Ø40	Ø40
COATING APERTURE	Ø40	Ø40
BEVEL	PROTECTED AS NEEDED	PROTECTED AS NEEDED

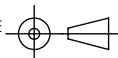
THIRD ANGLE PROJECTION 

ALL DIMS IN mm

 **Edmund Optics®**

TITLE: OD 2, Ø50mm, NIR ND FILTER

DWG NO: 62679

SHEET 1 OF 1