

**FOR INFORMATION ONLY:
DO NOT MANUFACTURE
PARTS TO THIS DRAWING**

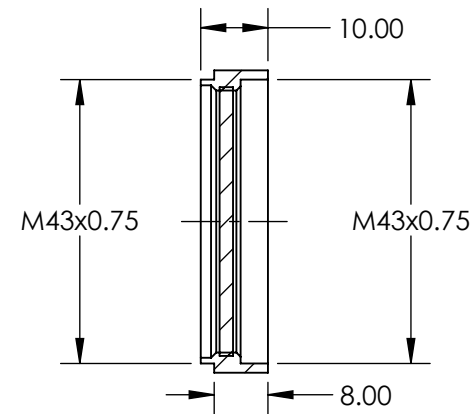

SECTION A-A

SPECIFICATIONS SUBJECT TO CHANGE WITHOUT NOTICE
DIMENSIONS ARE FOR REFERENCE ONLY

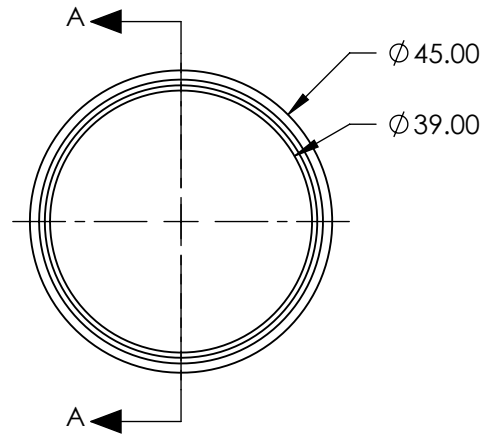

REV. A	VALUE
POLARIZATION EFFICIENCY	95%
TRANSMISSION	SINGLE: 30%; CROSSED: 0.15%

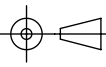
THIRD ANGLE PROJECTION 

ALL DIMS IN mm

TITLE	M43 x 0.75 MOUNTED LINEAR GLASS POLARIZING FILTER
DWG NO	52558
SHEET	1 OF 1