

**FOR INFORMATION ONLY:  
DO NOT MANUFACTURE  
PARTS TO THIS DRAWING**

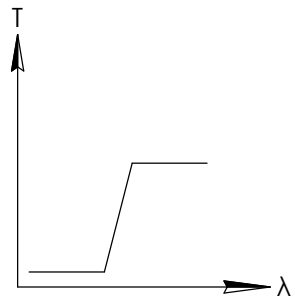
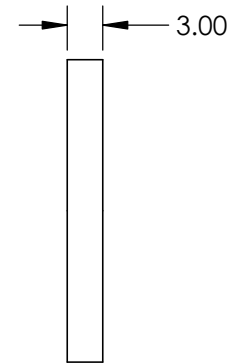
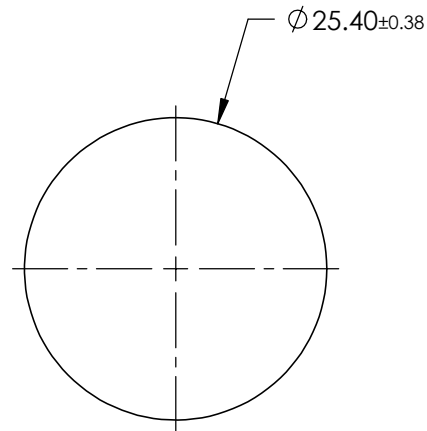
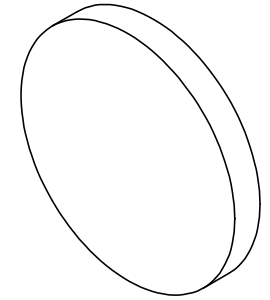

LONGPASS FILTER

SPECIFICATIONS SUBJECT TO CHANGE WITHOUT NOTICE  
DIMENSIONS ARE FOR REFERENCE ONLY

REV. A	VALUE
SHAPE	PLANO
SPECTRAL TRANSMITTANCE $\pm_{ip}(\%)$	92
PASSBAND LIMIT $\lambda_{p1}$ (nm)	530
CUT-OFF POSITION $\lambda_c$ (nm)	455 $\pm$ 6
STOPBAND LIMIT $\lambda_s$ (nm)	390
WAVELENGTH	VIS
BEVEL	PROTECTIVE AS NEEDED



THIRD ANGLE  
PROJECTION

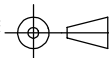

TITLE

$\varnothing 25.4\text{mm}$ , GG-455 LONGPASS FILTER

ALL DIMS IN

mm

DWG NO

45068

SHEET  
1 OF 1