

**FOR INFORMATION ONLY:
DO NOT MANUFACTURE
PARTS TO THIS DRAWING**

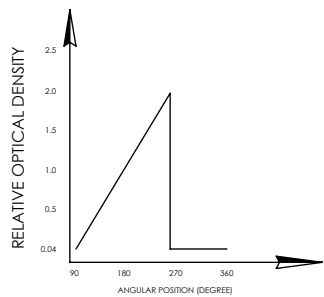
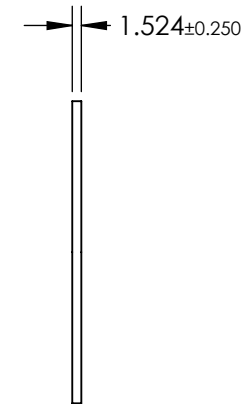
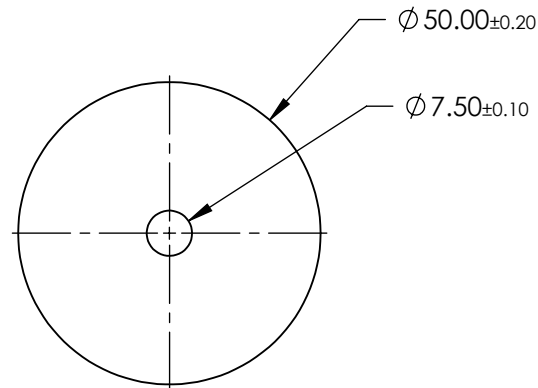
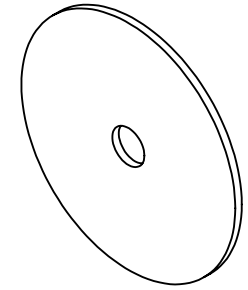

CIRCULAR VARIABLE FILTER

SPECIFICATIONS SUBJECT TO CHANGE WITHOUT NOTICE
DIMENSIONS ARE FOR REFERENCE ONLY

EO® Edmund Optics®

REV. A	S1	S2
SHAPE	PLANO	PLANO
SURFACE QUALITY	60-40	60-40
COATING	VARIABLE	VARIABLE
BEVEL	PROTECTIVE AS NEEDED	PROTECTIVE AS NEEDED



ALL DIMS IN

mm

TITLE

OD 0.04 - 4.0, Ø50mm, UNMOUNTED CIRCULAR
VARIABLE NEUTRAL DENSITY (ND) FILTER

DWG NO

43766

SHEET
1 OF 1