

**FOR INFORMATION ONLY:  
DO NOT MANUFACTURE  
PARTS TO THIS DRAWING**

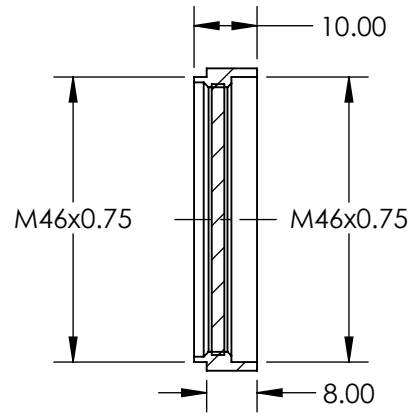

SECTION A-A

SPECIFICATIONS SUBJECT TO CHANGE WITHOUT NOTICE  
DIMENSIONS ARE FOR REFERENCE ONLY

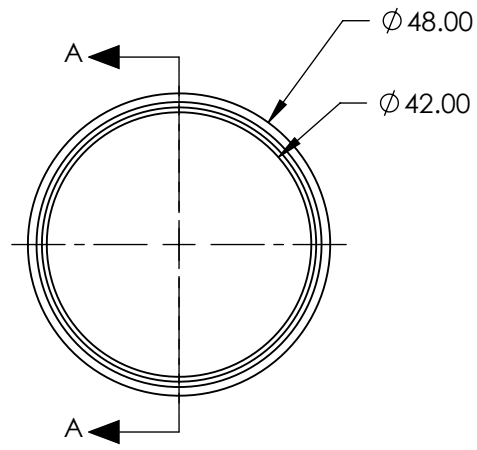
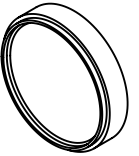

REV. A	VALUE
POLARIZATION EFFICIENCY	95%
TRANSMISSION	SINGLE: 30%; CROSSED: 0.15%

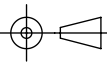
THIRD ANGLE PROJECTION 

ALL DIMS IN mm

TITLE	M46 x 0.75 MOUNTED LINEAR GLASS POLARIZING FILTER
DWG NO	36439
SHEET	1 OF 1