

**FOR INFORMATION ONLY:  
DO NOT MANUFACTURE  
PARTS TO THIS DRAWING**

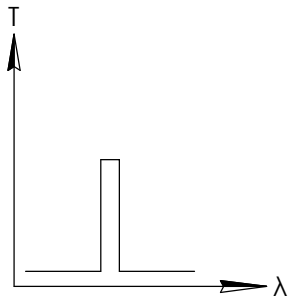
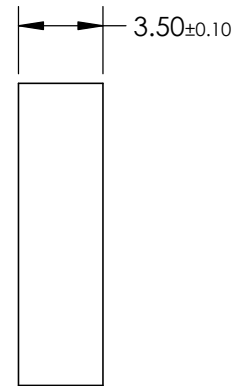
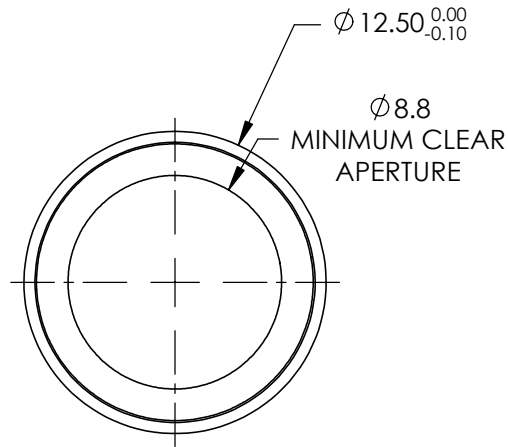
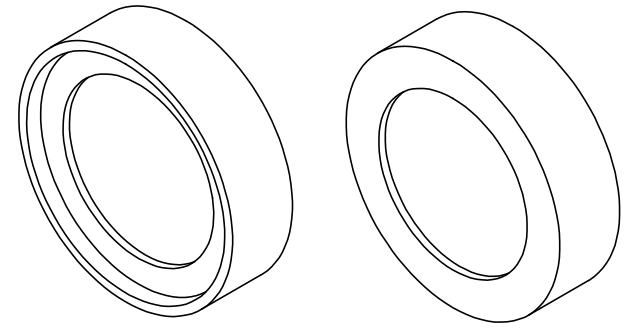

BANDPASS FILTER

REV. A	VALUE
CENTER WAVELENGTH (CWL)	620 ± 2nm
FULL WIDTH HALF MAX (FWHM)	60 ± 2nm
MINIMUM TRANSMISSION	>93%
BLOCKING	250 - 1100nm
SURFACE QUALITY	60-40
CONSTRUCTION	MOUNTED IN BLACK ANODIZED ALUMINUM RING
COATING TYPE	HARD COATED
DURABILITY	MIL-C-48497A, SECT. 3.4.1
ENVIRONMENTAL	MIL-STD-801F, SECT. 507.4

SPECIFICATIONS SUBJECT TO CHANGE WITHOUT NOTICE  
DIMENSIONS ARE FOR REFERENCE ONLY



ALL DIMS IN

mm

TITLE

OD6, Ø12.5mm, 620nm x 60nm, BP  
FLUORESCENCE FILTER

DWG NO

33909

SHEET  
1 OF 1