

**FOR INFORMATION ONLY:
DO NOT MANUFACTURE
PARTS TO THIS DRAWING**

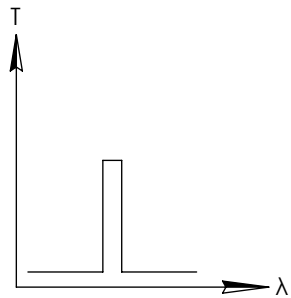
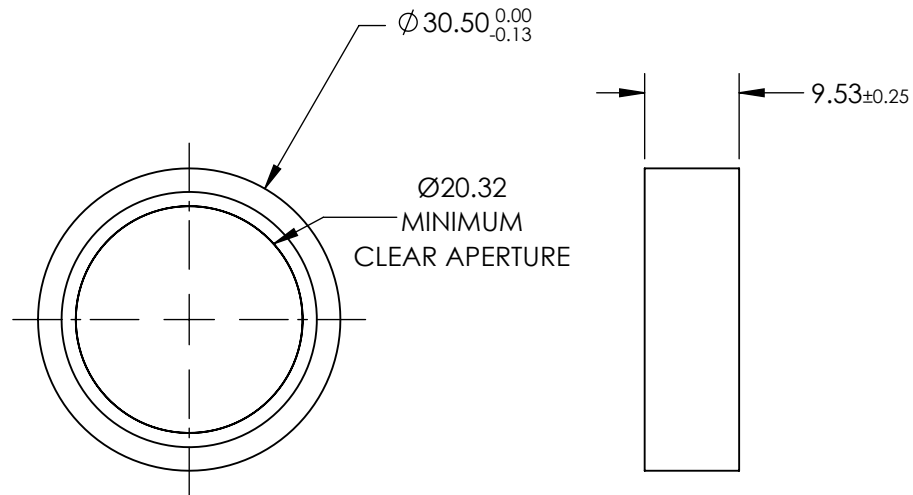
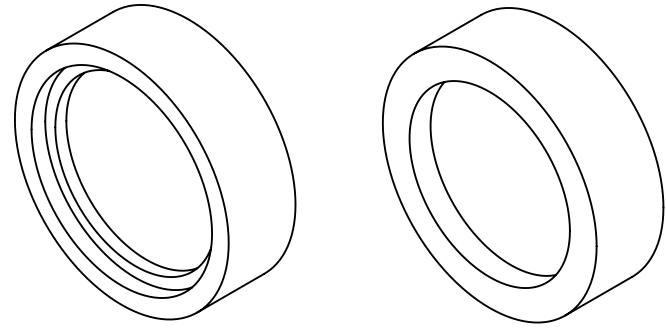

BANDPASS FILTER

SPECIFICATIONS SUBJECT TO CHANGE WITHOUT NOTICE
DIMENSIONS ARE FOR REFERENCE ONLY

REV. A	VALUE
CENTER WAVELENGTH (CWL)	248±2.5nm
FULL WIDTH HALF MAX (FWHM)	20 nm
MINIMUM TRANSMISSION	>15
SURFACE QUALITY	20-10
COATING TYPE	TRADITIONAL COATED



THIRD ANGLE PROJECTION		TITLE	Ø30.5mm, 248nm, DEEP UV BANDPASS FILTER
ALL DIMS IN	mm	DWG NO	33027
			SHEET 1 OF 1