

NOTES:

1. SUBSTRATE:
ELEMENT A: GRADE A FINE ANNEALED
SCHOTT: N-BK7 517/642

ELEMENT B: GRADE A FINE ANNEALED
SCHOTT: N-SF5 673/322
2. ROHS COMPLIANT
3. CENTERING TOLERANCE (AT 587.6nm):
BEAM DEVIATION (HALF ANGLE): <1 ARCMIN
4. COATING (APPLY ACROSS COATING APERTURE)
S1 & S4: VIS-NIR
R(ABS) ≤ 0.25% AT 880nm @ 0° AOI
R(AVG) ≤ 1.25% FROM 400-870nm @ 0° AOI
R(AVG) ≤ 1.25% FROM 890-1000nm @ 0° AOI
S2 & S3: NONE

- 5. FINE GRIND SURFACE
- 6. POWER, IRREGULARITY, AND SURFACE QUALITY SPECIFICATIONS APPLY ACROSS CLEAR APERTURE
- 7. FOCAL LENGTH (EFL): 500.00mm ±2%
BACK FOCAL LENGTH (BFL): 497.57mm
- 8. PROTECTIVE BEVEL AS NEEDED
- 9. DESIGN WAVELENGTH: 587.6nm
- 10. ELEMENTS TO BE CEMENTED WITH NORLAND OPTICAL ADHESIVE NOA61
- 11. BLACKENED SURFACE

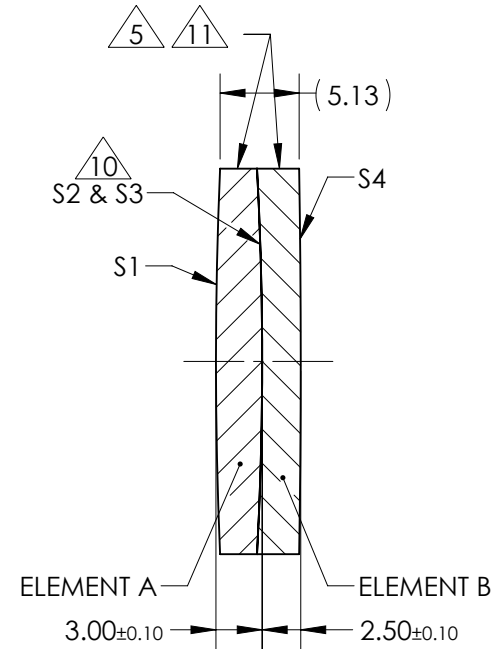
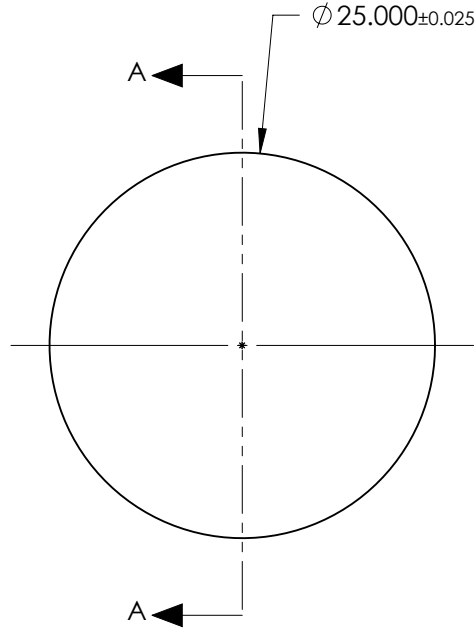

SECTION A-A

**FOR INFORMATION ONLY:
DO NOT MANUFACTURE
PARTS TO THIS DRAWING**

ELEMENT TITLE	SPECIFICATIONS AFTER CEMENTING			
	ELEMENT A		ELEMENT B	
SURFACE	S1	S2	S3	S4
SHAPE	CONVEX	CONVEX	CONCAVE	CONVEX
RADIUS	290.71	232.07	232.07	750.52
SURFACE QUALITY	40 - 20	40 - 20	40 - 20	40 - 20
MIN CLEAR APERTURE	∅ 24.00	∅ 24.00	∅ 24.00	∅ 24.00
MIN COATING APERTURE	∅ 24.00	N/A	N/A	∅ 24.00
POWER AT 632.8nm	3.00 RINGS	3.00 RINGS	3.00 RINGS	3.00 RINGS
IRREGULARITY AT 632.8nm	0.50 RINGS	0.50 RINGS	0.50 RINGS	0.50 RINGS

SPECIFICATIONS SUBJECT TO CHANGE WITHOUT NOTICE
DIMENSIONS ARE FOR REFERENCE ONLY

EO® Edmund Optics®

THIRD ANGLE PROJECTION		TITLE	25mm Dia. x 500mm FL, VIS-NIR, Inked, Achromatic Lens
ALL DIMS IN	mm	DWG NO	49370INK
			SHEET 1 OF 1