

NOTES:

1. SUBSTRATE:
GRADE A FINE ANNEALED
SCHOTT: N-BK7 517/642
2. ROHS COMPLIANT
3. CENTERING TOLERANCE (AT 587.6nm):
BEAM DEVIATION (HALF ANGLE): <1 ARCMIN
4. COATING (APPLY ACROSS COATING APERTURE)
S1 & S2: YAG-BBAR
R(ABS) < 0.25% @ 532nm @ 0° AOI
R(ABS) < 0.25% @ 1064nm @ 0° AOI
R(AVG) < 1.0% FROM 500-1100nm @ 0° AOI
5. FINE GRIND SURFACE
6. POWER, IRREGULARITY, AND SURFACE QUALITY SPECIFICATIONS APPLY ACROSS CLEAR APERTURE
7. FOCAL LENGTH (EFL): 27.00mm±1%
BACK FOCAL LENGTH (BFL): 25.34mm
8. PROTECTIVE BEVEL AS NEEDED
9. DESIGN WAVELENGTH: 587.6nm
10. BLACKENED SURFACE

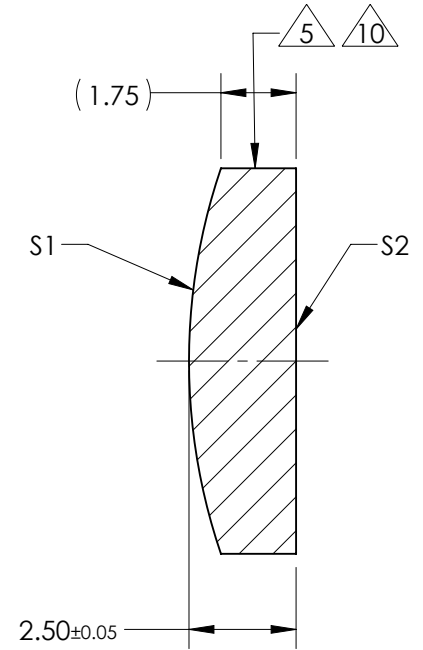
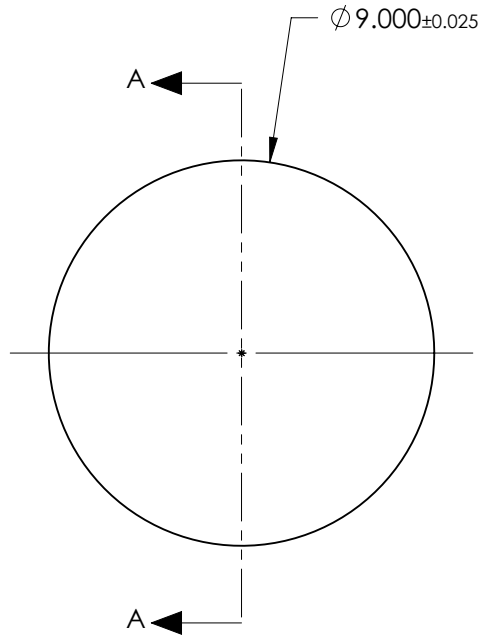

SECTION A-A

**FOR INFORMATION ONLY:
DO NOT MANUFACTURE
PARTS TO THIS DRAWING**

	S1	S2
SHAPE	CONVEX	PLANO
RADIUS	13.95	INFINITY
SURFACE QUALITY	40 - 20	40 - 20
MIN CLEAR APERTURE	Ø8.10	Ø8.10
MIN COATING APERTURE	Ø8.00	Ø8.00
POWER AT 632.8nm	3.00 RINGS	3.00 RINGS
IRREGULARITY AT 632.8nm	0.50 RINGS	0.50 RINGS

SPECIFICATIONS SUBJECT TO CHANGE WITHOUT NOTICE
DIMENSIONS ARE FOR REFERENCE ONLY

EO® **Edmund Optics**®

THIRD ANGLE PROJECTION		TITLE	9.0mm Dia. x 27.0mm FL, YAG-BBAR, Inked, Plano-Convex Lens
ALL DIMS IN	mm	DWG NO	88815INK
			SHEET 1 OF 1