

NOTES:

1. SUBSTRATE:
CORNING: FUSED SILICA 458/678
2. ROHS COMPLIANT
3. CENTERING TOLERANCE (AT 587.6nm):
BEAM DEVIATION (HALF ANGLE): <1 ARCMIN
4. COATING (APPLY ACROSS COATING APERTURE)
S1 & S2: 405nm V-COAT
R(ABS) < 0.25% @ 405nm @ 0° AOI
5. FINE GRIND SURFACE
6. POWER, IRREGULARITY, AND SURFACE QUALITY SPECIFICATIONS APPLY ACROSS CLEAR APERTURE
7. FOCAL LENGTH (EFL): 20.00mm±1%
BACK FOCAL LENGTH (BFL): 18.97mm
8. PROTECTIVE BEVEL AS NEEDED
9. DESIGN WAVELENGTH: 405nm

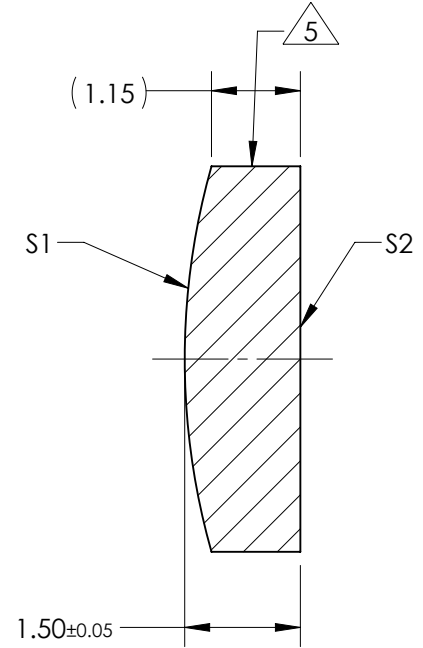
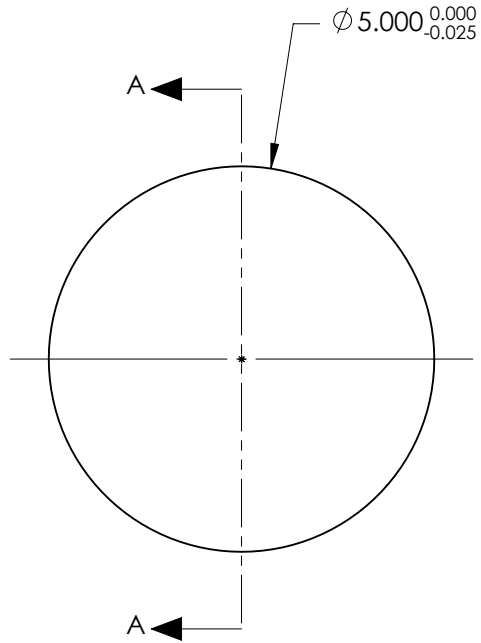

SECTION A-A

**FOR INFORMATION ONLY:
DO NOT MANUFACTURE
PARTS TO THIS DRAWING**

	S1	S2
SHAPE	CONVEX	PLANO
RADIUS	9.17	INFINITY
SURFACE QUALITY	40 - 20	40 - 20
MIN CLEAR APERTURE	∅ 4.50	∅ 4.50
MIN COATING APERTURE	∅ 4.00	∅ 4.00
POWER AT 632.8nm	3.00 RINGS	3.00 RINGS
IRREGULARITY AT 632.8nm	0.50 RINGS	0.50 RINGS

SPECIFICATIONS SUBJECT TO CHANGE WITHOUT NOTICE
DIMENSIONS ARE FOR REFERENCE ONLY

EO® **Edmund Optics**®

THIRD ANGLE PROJECTION		TITLE	5mm Dia. x 20mm FL 405nm V-Coat, UV PCX Lens
ALL DIMS IN	mm	DWG NO	34062
			SHEET 1 OF 1