

NOTES:

1. SUBSTRATE  
UV GRADE FUSED SILICA
2. SURFACE S2 TO BE PARALLEL WITH SURFACE S1 TO WITHIN 5 ARCSEC
3. COATING (APPLY ACROSS COATING APERTURE)

PERFORMANCE SPECIFICATIONS @ 0° AOI  
 T(AVG): >85% FROM 1240 - 2000nm  
 T(AVG): < 1% FROM 920 - 1160nm  
 T(ABS): = 50% @ 1200nm

S1: MULTILAYER DIELECTRIC COATING  
 S2: SINGLE LAYER MgF2

**FOR INFORMATION ONLY:  
 DO NOT MANUFACTURE  
 PARTS TO THIS DRAWING**

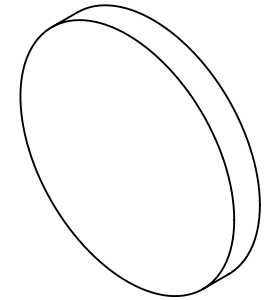

4. FINE GRIND SURFACE

5. TRANSMITTED WAVEFRONT DISTORTION RMS@ 632.8nm ≤ ¼ WAVE
6. ROHS COMPLIANT

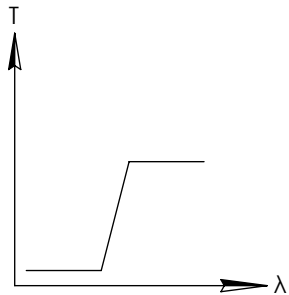
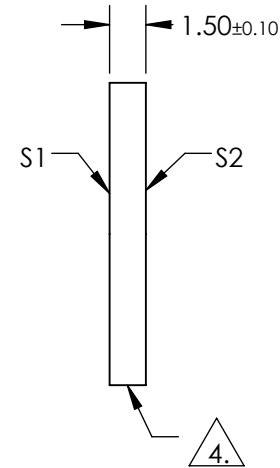
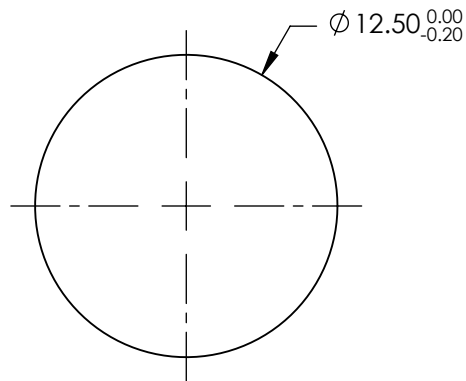

LONGPASS FILTER

SPECIFICATIONS SUBJECT TO CHANGE WITHOUT NOTICE  
 DIMENSIONS ARE FOR REFERENCE ONLY

	S1	S2
SHAPE	PLANO	PLANO
SURFACE QUALITY	40-20	40-20
CLEAR APERTURE	80%	80%
COATING APERTURE	Ø11.00	Ø11.00
BEVEL	PROTECTIVE AS NEEDED	PROTECTIVE AS NEEDED

THIRD ANGLE PROJECTION

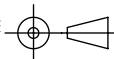

ALL DIMS IN

mm

**EO**® Edmund Optics®

TITLE

OD2, Ø12.5mm, 1200nm LONGPASS FILTER

DWG NO

67296

SHEET  
1 OF 1