

NOTES:

1. SUBSTRATE
UV GRADE FUSED SILICA
2. SURFACE S2 TO BE PARALLEL WITH SURFACE S1 TO WITHIN 5 ARCSEC
3. COATING (APPLY ACROSS COATING APERTURE)

PERFORMANCE SPECIFICATIONS @ 0° AOI
 T(AVG): >85% FROM 935 - 2000nm
 T(AVG): < 1% FROM 675 - 855nm
 T(ABS): = 50% @ 900nm

S1: MULTILAYER DIELECTRIC COATING
 S2: SINGLE LAYER MgF2

**FOR INFORMATION ONLY:
 DO NOT MANUFACTURE
 PARTS TO THIS DRAWING**

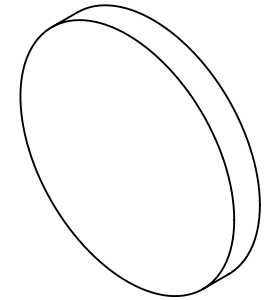

4. FINE GRIND SURFACE

5. TRANSMITTED WAVEFRONT DISTORTION RMS@ 632.8nm ≤ ¼ WAVE
6. ROHS COMPLIANT

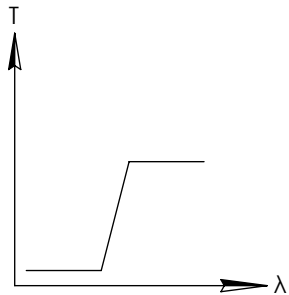
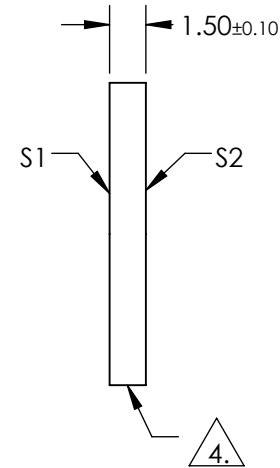
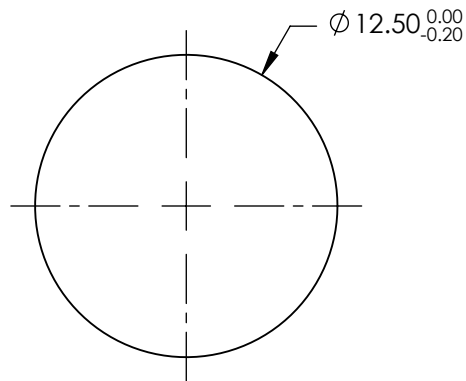

LONGPASS FILTER

SPECIFICATIONS SUBJECT TO CHANGE WITHOUT NOTICE
 DIMENSIONS ARE FOR REFERENCE ONLY

	S1	S2
SHAPE	PLANO	PLANO
SURFACE QUALITY	40-20	40-20
CLEAR APERTURE	80%	80%
COATING APERTURE	Ø11.00	Ø11.00
BEVEL	PROTECTIVE AS NEEDED	PROTECTIVE AS NEEDED

EO® Edmund Optics®

THIRD ANGLE PROJECTION

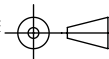

TITLE

OD2, Ø12.5mm, 900nm LONGPASS FILTER

ALL DIMS IN

mm

DWG NO

49034

SHEET
1 OF 1