

NOTES:

1. SUBSTRATE: UV GRADE FUSED SILICA
2. COATING (APPLY ACROSS COATING APERTURE)

DURABILITY: MIL-C-48497A, SECT. 3.4.1

PERFORMANCE SPECIFICATIONS @ 0° AOI
 T(AVG): ≥91% FROM 400 - 810nm
 T(AVG): ≤0.01% FROM 850 - 1190nm
 CUT-OFF SLOPE: <1%
 CUT-OFF WAVELENGTH: 825nm ± 1%

**FOR INFORMATION ONLY:
 DO NOT MANUFACTURE
 PARTS TO THIS DRAWING**

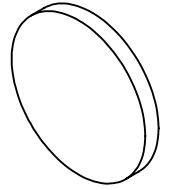

3. FINE GRIND SURFACE
4. TRANSMITTED WAVEFRONT DISTORTION RMS @ 632.8nm ≤ 1/4 λ
5. ROHS COMPLIANT
6. ARROW POINTS TOWARDS THE FILTER COATED SURFACE

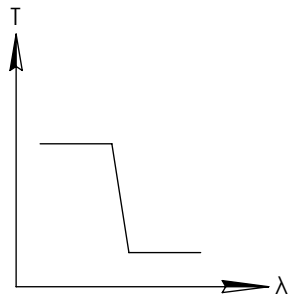
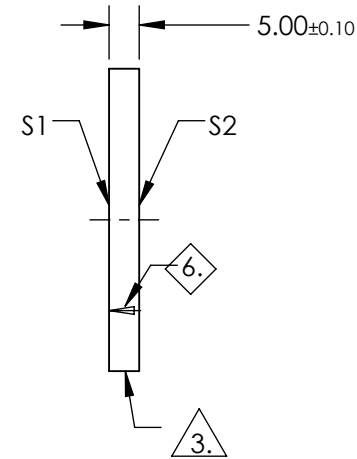
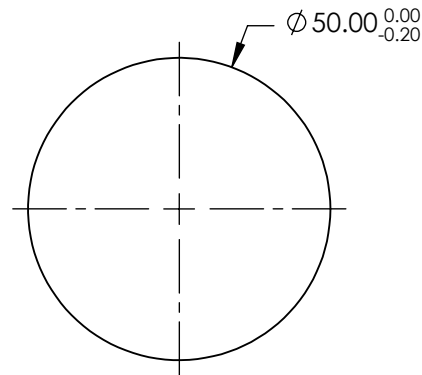

SHORTPASS FILTER

SPECIFICATIONS SUBJECT TO CHANGE WITHOUT NOTICE
 DIMENSIONS ARE FOR REFERENCE ONLY



	S1	S2
SHAPE	PLANO	PLANO
SURFACE QUALITY	60-40	60-40
CLEAR APERTURE	>80%	>80%
BEVEL	PROTECTIVE AS NEEDED	PROTECTIVE AS NEEDED

THIRD ANGLE PROJECTION

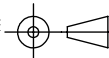

ALL DIMS IN

mm

TITLE

825nm 50mm Diameter, OD 4 Shortpass Filter

DWG NO

86113

SHEET
1 OF 1