

NOTES:

1. SUBSTRATE: UV GRADE FUSED SILICA
 2. COATING (APPLY ACROSS COATING APERTURE)
- DURABILITY: MIL-C-48497A, SECT. 3.4.1

PERFORMANCE SPECIFICATIONS @ 0° AOI
 T(AVG): ≥91% FROM 400 - 810nm
 T(AVG): ≤ 0.01% FROM 850 - 1190nm
 CUT-OFF SLOPE: <1%
 CUT-OFF WAVELENGTH: 825nm ± 1%

**FOR INFORMATION ONLY:
 DO NOT MANUFACTURE
 PARTS TO THIS DRAWING**

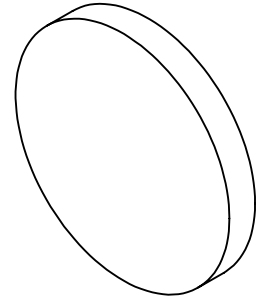

3. FINE GRIND SURFACE

4. TRANSMITTED WAVEFRONT DISTORTION RMS @ 632.8nm ≤ 1/4 λ
5. ROHS COMPLIANT

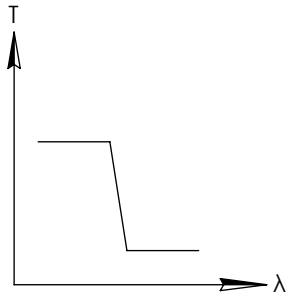
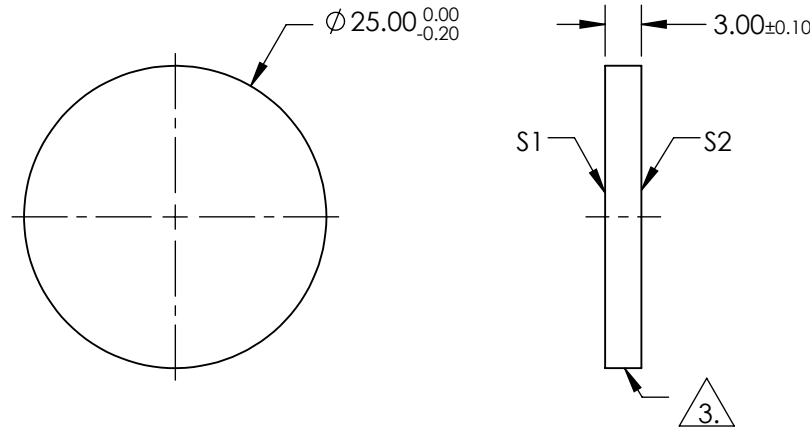

SHORTPASS FILTER

SPECIFICATIONS SUBJECT TO CHANGE WITHOUT NOTICE
 DIMENSIONS ARE FOR REFERENCE ONLY



	S1	S2
SHAPE	PLANO	PLANO
SURFACE QUALITY	60-40	60-40
CLEAR APERTURE	>80%	>80%
BEVEL	PROTECTIVE AS NEEDED	PROTECTIVE AS NEEDED

THIRD ANGLE PROJECTION

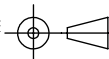

ALL DIMS IN

mm

TITLE

825nm 25mm Diameter, OD 4 Shortpass Filter

DWG NO

86105

SHEET
1 OF 1