

**FOR INFORMATION ONLY:  
DO NOT MANUFACTURE  
PARTS TO THIS DRAWING**

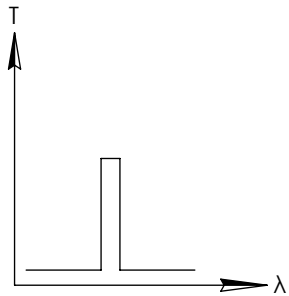
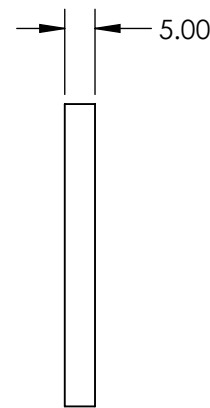
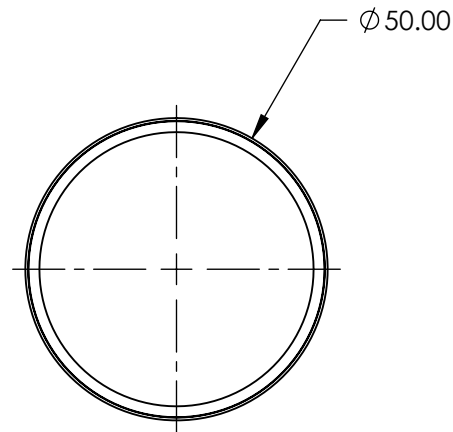
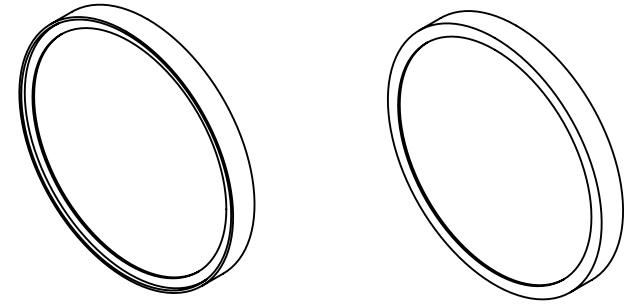

BANDPASS FILTER

REV. A	VALUE
CENTER WAVELENGTH (CWL)	700 ± 3 nm
FULL WIDTH HALF MAX (FWHM)	25 ± 3 nm
MINIMUM TRANSMISSION	≥90
BLOCKING	200 - 1200nm
SURFACE QUALITY	80-50
COATING TYPE	HARD COATED
DURABILITY	MIL-C-48497A
ENVIRONMENTAL	MIL-STD-810F

SPECIFICATIONS SUBJECT TO CHANGE WITHOUT NOTICE  
DIMENSIONS ARE FOR REFERENCE ONLY

**EO**® Edmund Optics®



THIRD ANGLE  
PROJECTION

TITLE	OD4, Ø50mm, 700nm x 25nm, HD BANDPASS FILTER
DWG NO	86670
SHEET	1 OF 1

ALL DIMS IN

mm