

**FOR INFORMATION ONLY:
DO NOT MANUFACTURE
PARTS TO THIS DRAWING**

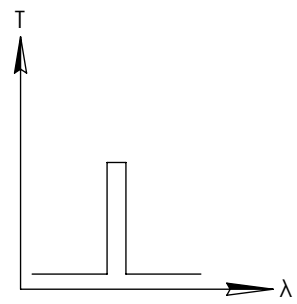
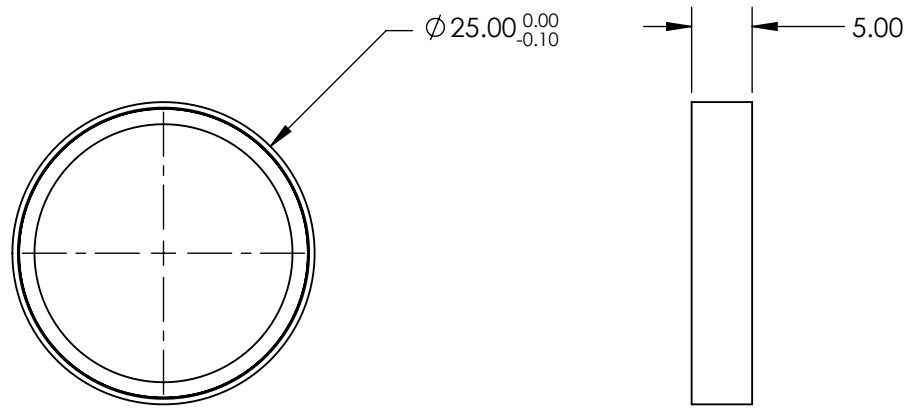
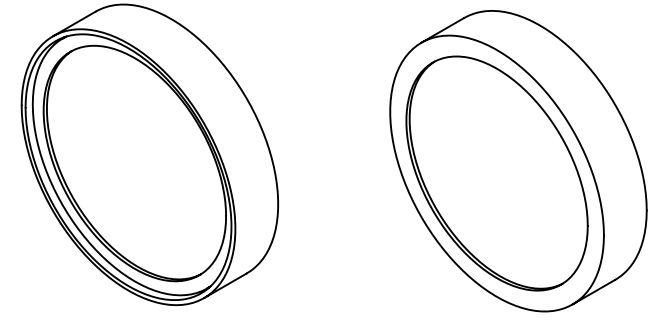

BANDPASS FILTER

REV. A	VALUE
CENTER WAVELENGTH (CWL)	850 ± 3 nm
FULL WIDTH HALF MAX (FWHM)	25 ± 3 nm
MINIMUM TRANSMISSION	≥90
BLOCKING	200 - 1200nm
SURFACE QUALITY	80-50
COATING TYPE	HARD COATED
DURABILITY	MIL-C-48497A
ENVIRONMENTAL	MIL-STD-810F

SPECIFICATIONS SUBJECT TO CHANGE WITHOUT NOTICE
DIMENSIONS ARE FOR REFERENCE ONLY



THIRD ANGLE PROJECTION		TITLE	OD4, Ø25mm, 850nm x 25nm, HD BANDPASS FILTER
ALL DIMS IN	mm	DWG NO	86661
			SHEET 1 OF 1