

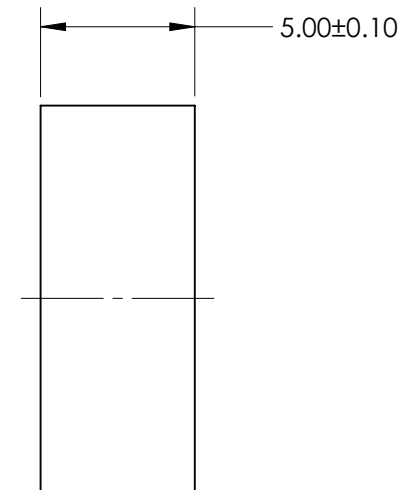

**FOR INFORMATION ONLY:
DO NOT MANUFACTURE
PARTS TO THIS DRAWING**

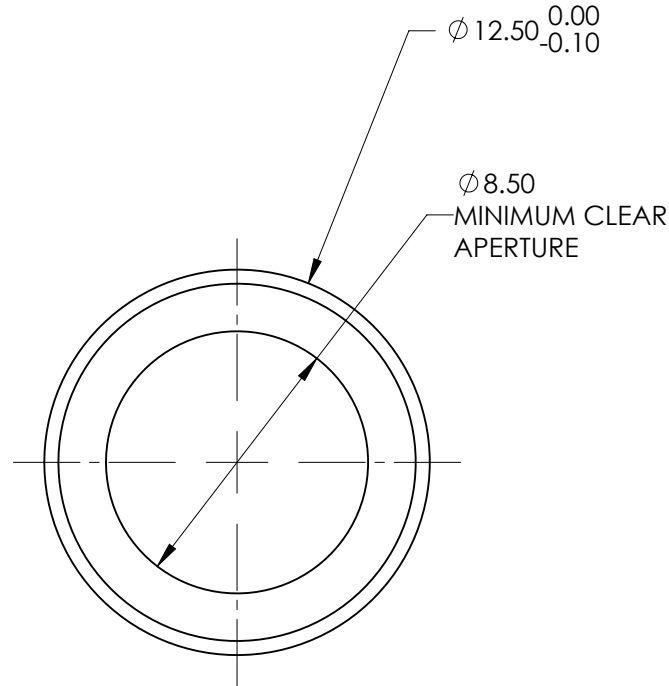
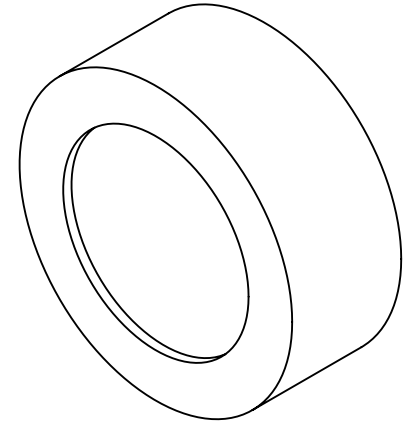
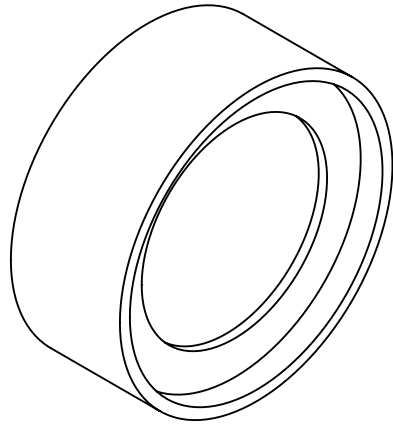

SPECIFICATION	VALUE
CENTER WAVELENGTH (CWL)	900nm \pm 5nm
FULL WIDTH HALF MAX (FWHM)	50nm \pm 5nm
MINIMUM TRANSMISSION	>90%
BLOCKING	OD > 4.0 FROM 200 TO 1200nm
SURFACE QUALITY	80 - 50
CONSTRUCTION	MOUNTED IN BLACK ANODIZED ALUMINUM RING
COATING TYPE	HARD COATED
DURABILITY	MIL-C-48497A, SECT. 3.4.1
ENVIRONMENTAL	MIL-STD-810F, SECT. 507.4

SPECIFICATIONS SUBJECT TO CHANGE WITHOUT NOTICE
DIMENSIONS ARE FOR REFERENCE ONLY

EFL (AT 587.6nm)	NA	 Edmund Optics®		
BFL (AT 587.6nm)	NA			TITLE
ALL DIMS IN	mm	DWG NO	84779	SHEET 1 OF 1