

NOTES:

1. SUBSTRATE:
ELEMENT A: GRADE A FINE ANNEALED
SCHOTT: N-FK5 487/704

ELEMENT B: GRADE A FINE ANNEALED
SCHOTT: F2HT 620/364
2. ROHS COMPLIANT
3. CENTERING TOLERANCE (AT 587.6nm):
BEAM DEVIATION (HALF ANGLE): <1 ARCMIN
4. COATING (APPLY ACROSS COATING APERTURE)
S1 & S4: UV-VIS
R(AVG) ≤ 1.5% FROM 250-700nm @ 0° AOI
R(ABS) ≤ 1.0% FROM 350-450nm @ 0° AOI
S2 & S3: NONE
5. FINE GRIND SURFACE
6. POWER, IRREGULARITY, AND SURFACE QUALITY SPECIFICATIONS APPLY ACROSS CLEAR APERTURE
7. FOCAL LENGTH (EFL): 15.00mm ±2%
BACK FOCAL LENGTH (BFL): 13.05mm
8. PROTECTIVE BEVEL AS NEEDED
9. DESIGN WAVELENGTH: 405nm
10. ELEMENTS TO BE CEMENTED WITH DENKA OP-1030K OR EQUIVALENT

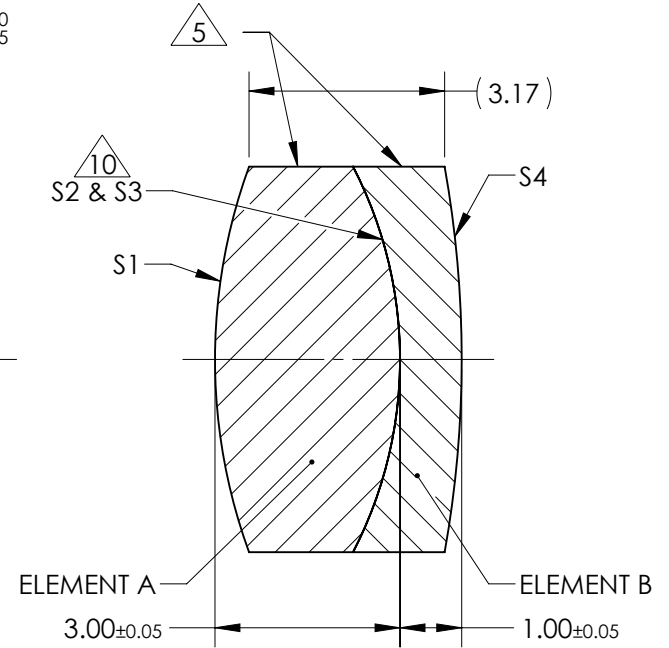
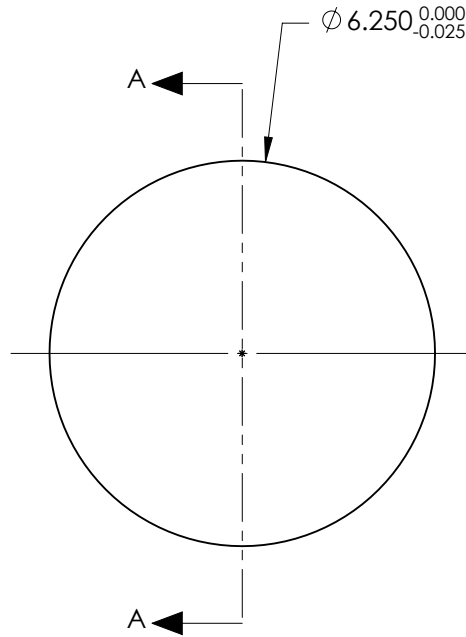

SECTION A-A

**FOR INFORMATION ONLY:
DO NOT MANUFACTURE
PARTS TO THIS DRAWING**

ELEMENT TITLE	SPECIFICATIONS AFTER CEMENTING			
	ELEMENT A		ELEMENT B	
SURFACE	S1	S2	S3	S4
SHAPE	CONVEX	CONVEX	CONCAVE	CONVEX
RADIUS	9.12	6.79	6.79	17.77
SURFACE QUALITY	40 - 20	40 - 20	40 - 20	40 - 20
MIN CLEAR APERTURE	∅ 5.63	∅ 5.63	∅ 5.63	∅ 5.63
MIN COATING APERTURE	∅ 5.25	N/A	N/A	∅ 5.25
POWER AT 632.8nm	3.00 RINGS	3.00 RINGS	3.00 RINGS	3.00 RINGS
IRREGULARITY AT 632.8nm	0.50 RINGS	0.50 RINGS	0.50 RINGS	0.50 RINGS

SPECIFICATIONS SUBJECT TO CHANGE WITHOUT NOTICE
DIMENSIONS ARE FOR REFERENCE ONLY

EO® Edmund Optics®

THIRD ANGLE PROJECTION		TITLE	6.25mm Dia. x 15mm EFL, UV-VIS Coated, Near UV Achromatic Lens	
ALL DIMS IN	mm	DWG NO	84328	SHEET 1 OF 1