

NOTES:

1. SUBSTRATE:
CORNING: FUSED SILICA 458/678
2. ROHS COMPLIANT
3. CENTERING TOLERANCE (AT 587.6nm):
BEAM DEVIATION (HALF ANGLE): <1 ARCMIN
4. COATING (APPLY ACROSS COATING APERTURE)

S1: NONE
S2: NONE

5. FINE GRIND SURFACE
6. POWER, IRREGULARITY, AND SURFACE QUALITY SPECIFICATIONS APPLY ACROSS CLEAR APERTURE
7. FOCAL LENGTH (EFL): 250.00mm ±1%
BACK FOCAL LENGTH (BFL): 248.14mm
8. PROTECTIVE BEVEL AS NEEDED
9. DESIGN WAVELENGTH: 587.6nm

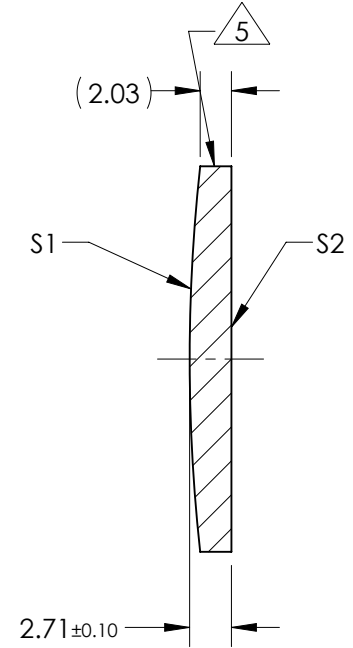
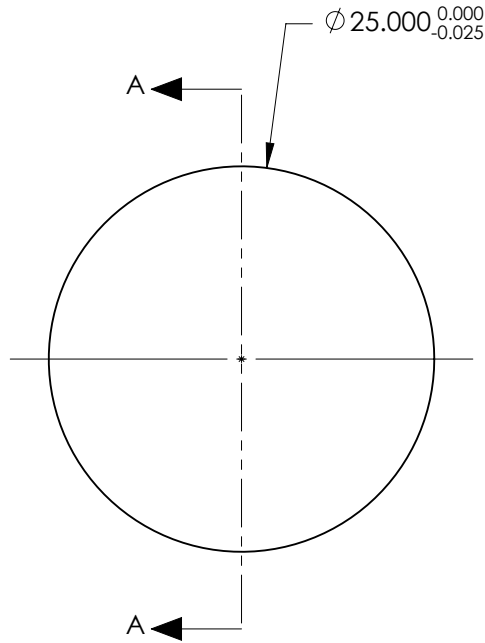

SECTION A-A

**FOR INFORMATION ONLY:
DO NOT MANUFACTURE
PARTS TO THIS DRAWING**

	S1	S2
SHAPE	CONVEX	PLANO
RADIUS	114.62	INFINITY
SURFACE QUALITY	20 - 10	20 - 10
MIN CLEAR APERTURE	∅ 24.00	∅ 24.00
MIN COATING APERTURE	N/A	N/A
POWER AT 632.8nm	2.00 RINGS	2.00 RINGS
IRREGULARITY AT 632.8nm	0.20 RINGS	0.20 RINGS

SPECIFICATIONS SUBJECT TO CHANGE WITHOUT NOTICE
DIMENSIONS ARE FOR REFERENCE ONLY

EO® Edmund Optics®

TITLE	25mm Diameter x 250mm FL, Uncoated, Laser Grade PCX Lens	
DWG NO	67099	SHEET 1 OF 1

THIRD ANGLE PROJECTION

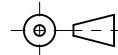

ALL DIMS IN mm