

**FOR INFORMATION ONLY:
DO NOT MANUFACTURE
PARTS TO THIS DRAWING**

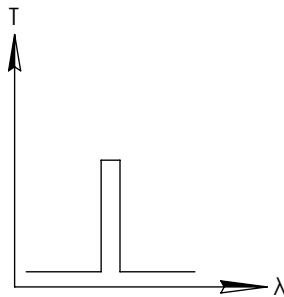

BANDPASS FILTER

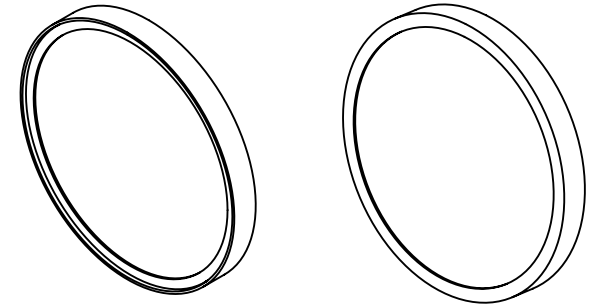
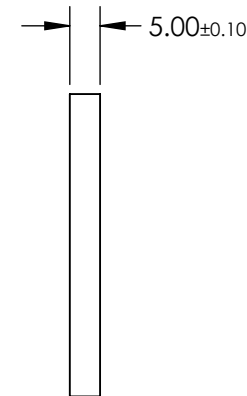
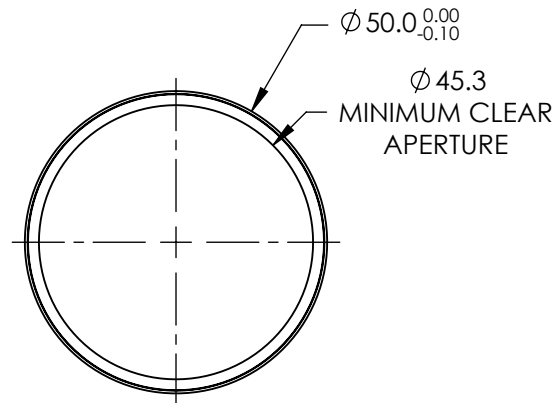

REV. 001	VALUE
CENTER WAVELENGTH (CWL)	$589 \pm 2\text{nm}$
FULL WIDTH HALF MAX (FWHM)	$10 \pm 2\text{nm}$
MINIMUM TRANSMISSION	$\geq 85\%$
BLOCKING	200 - 1200nm
SURFACE QUALITY	80-50
CONSTRUCTION	MOUNTED IN BLACK ANODIZED ALUMINUM RING
COATING TYPE	HARD COATED
DURABILITY	MIL-C-48497A, SECT. 3.4.1
ENVIRONMENTAL	MIL-STD-801F, SECT. 507.4

SPECIFICATIONS SUBJECT TO CHANGE WITHOUT NOTICE
DIMENSIONS ARE FOR REFERENCE ONLY

EO® Edmund Optics®



TITLE

OD4, Ø50mm, 589nm x 10nm, HC, BP FILTER

ALL DIMS IN

mm

DWG NO

65223

SHEET
1 OF 1