

**FOR INFORMATION ONLY:  
DO NOT MANUFACTURE  
PARTS TO THIS DRAWING**

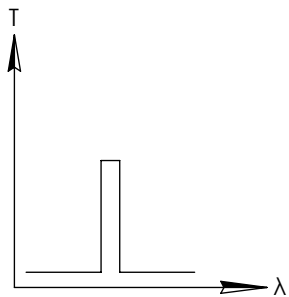
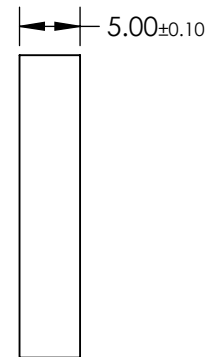
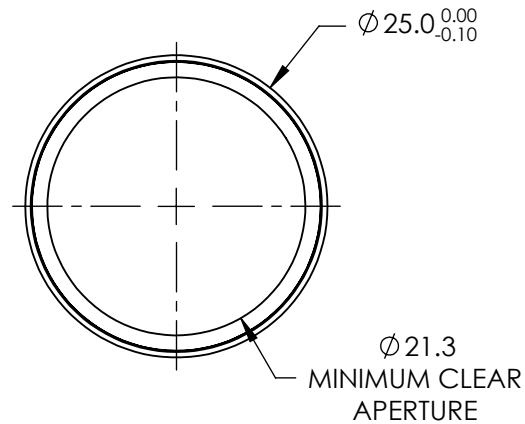
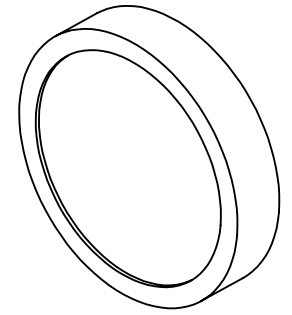

BANDPASS FILTER

SPECIFICATIONS SUBJECT TO CHANGE WITHOUT NOTICE  
DIMENSIONS ARE FOR REFERENCE ONLY

	VALUE
CENTER WAVELENGTH (nm)	766nm
FULL WIDTH HALF MAX (nm)	10nm
MINIMUM TRANSMISSION	$\geq 85$
BLOCKING	200 - 1200
SURFACE QUALITY	80-50
CONSTRUCTION	MOUNTED IN BLACK ANODIZED ALUMINUM RING
COATING TYPE	HARD COATED

**EO**® Edmund Optics®

THIRD ANGLE PROJECTION	TITLE	OD4, $\varnothing 25$ mm, 766nm x 10nm, HC, BP FILTER	
ALL DIMS IN	mm	DWG NO	65177
			SHEET 1 OF 1