

**FOR INFORMATION ONLY:
DO NOT MANUFACTURE
PARTS TO THIS DRAWING**

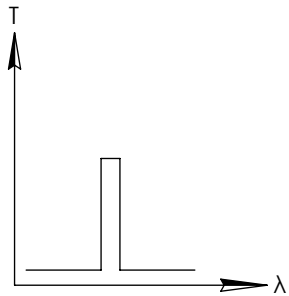
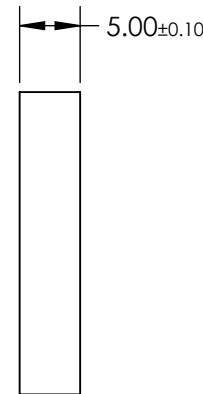
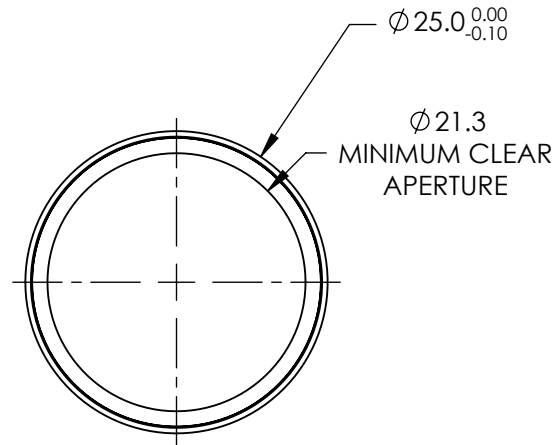
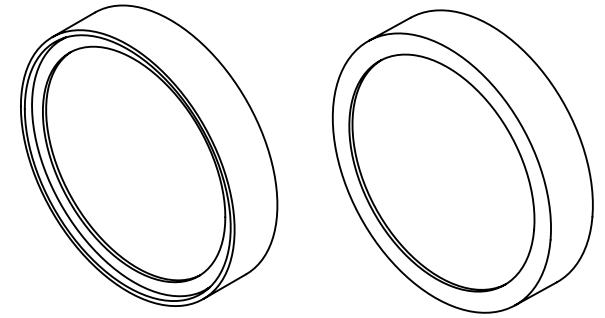

BANDPASS FILTER

REV. 001	VALUE
CENTER WAVELENGTH (CWL)	640 ± 2 nm
FULL WIDTH HALF MAX (FWHM)	10 ± 2 nm
MINIMUM TRANSMISSION	≥85%
BLOCKING	200 - 1200nm
SURFACE QUALITY	80-50
CONSTRUCTION	MOUNTED IN BLACK ANODIZED ALUMINUM RING
COATING TYPE	HARD COATED
DURABILITY	MIL-C-48497A, SECT. 3.4.1
ENVIRONMENTAL	MIL-STD-801F, SECT. 507.4

SPECIFICATIONS SUBJECT TO CHANGE WITHOUT NOTICE
DIMENSIONS ARE FOR REFERENCE ONLY



ALL DIMS IN

mm

TITLE

OD4, Ø25mm, 640nm x 10nm, HC, BP FILTER

DWG NO

65168

SHEET
1 OF 1