

**FOR INFORMATION ONLY:
DO NOT MANUFACTURE
PARTS TO THIS DRAWING**

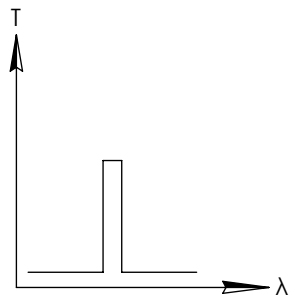
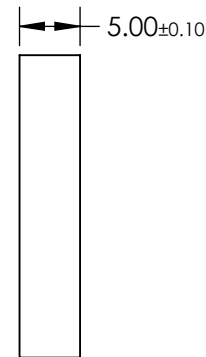
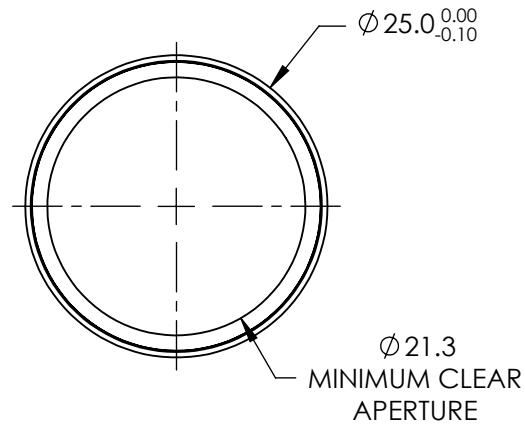
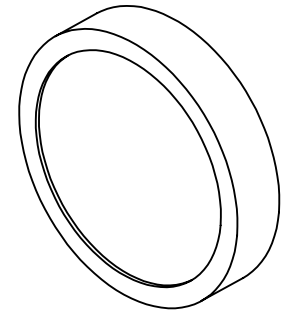

BANDPASS FILTER

SPECIFICATIONS SUBJECT TO CHANGE WITHOUT NOTICE
DIMENSIONS ARE FOR REFERENCE ONLY

	VALUE
CENTER WAVELENGTH (nm)	500nm
FULL WIDTH HALF MAX (nm)	10nm
MINIMUM TRANSMISSION	≥85
BLOCKING	200 - 1200
SURFACE QUALITY	80-50
CONSTRUCTION	MOUNTED IN BLACK ANODIZED ALUMINUM RING
COATING TYPE	HARD COATED

EO® Edmund Optics®

THIRD ANGLE PROJECTION	TITLE	OD4, Ø25mm, 500nm x 10nm, HC, BP FILTER	
ALL DIMS IN	mm	DWG NO	65149
			SHEET 1 OF 1