

**FOR INFORMATION ONLY:  
DO NOT MANUFACTURE  
PARTS TO THIS DRAWING**

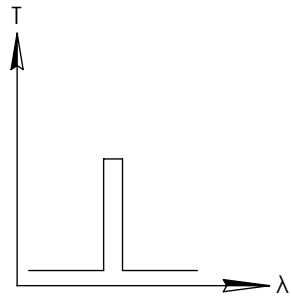

BANDPASS FILTER

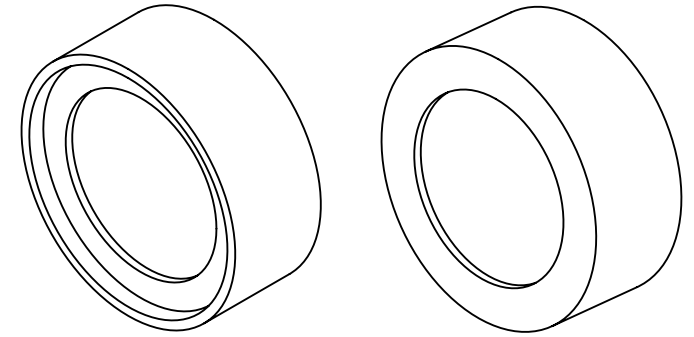
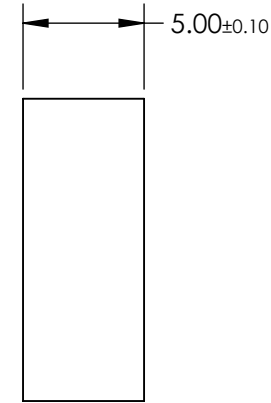
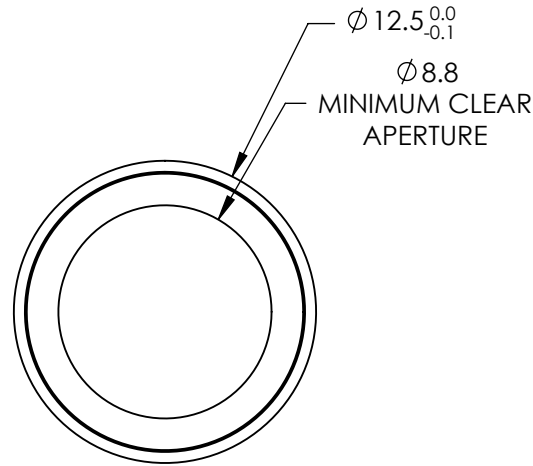

REV. 001	VALUE
CENTER WAVELENGTH (CWL)	640 $\pm$ 2nm
FULL WIDTH HALF MAX (FWHM)	10 $\pm$ 2nm
MINIMUM TRANSMISSION	$\geq$ 85%
BLOCKING	200 - 1200nm
SURFACE QUALITY	80-50
CONSTRUCTION	MOUNTED IN BLACK ANODIZED ALUMINUM RING
COATING TYPE	HARD COATED
DURABILITY	MIL-C-48497A, SECT. 3.4.1
ENVIRONMENTAL	MIL-STD-801F, SECT. 507.4

SPECIFICATIONS SUBJECT TO CHANGE WITHOUT NOTICE  
DIMENSIONS ARE FOR REFERENCE ONLY

**EO**® Edmund Optics®



TITLE

OD4, Ø12.5mm, 640nm x 10nm, HC, BP FILTER

ALL DIMS IN

mm

DWG NO

65107

SHEET  
1 OF 1