

A

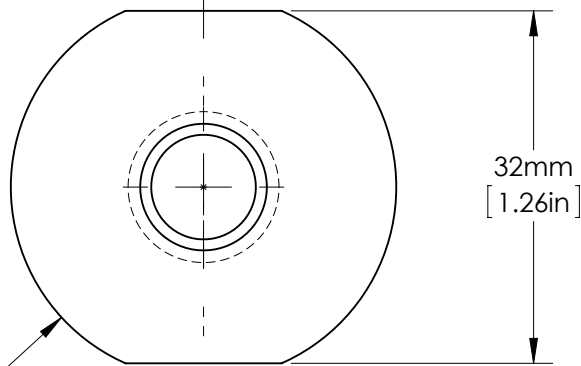

A

10mm MAX THICKNESS OF OPTIC
[.394in MAX]

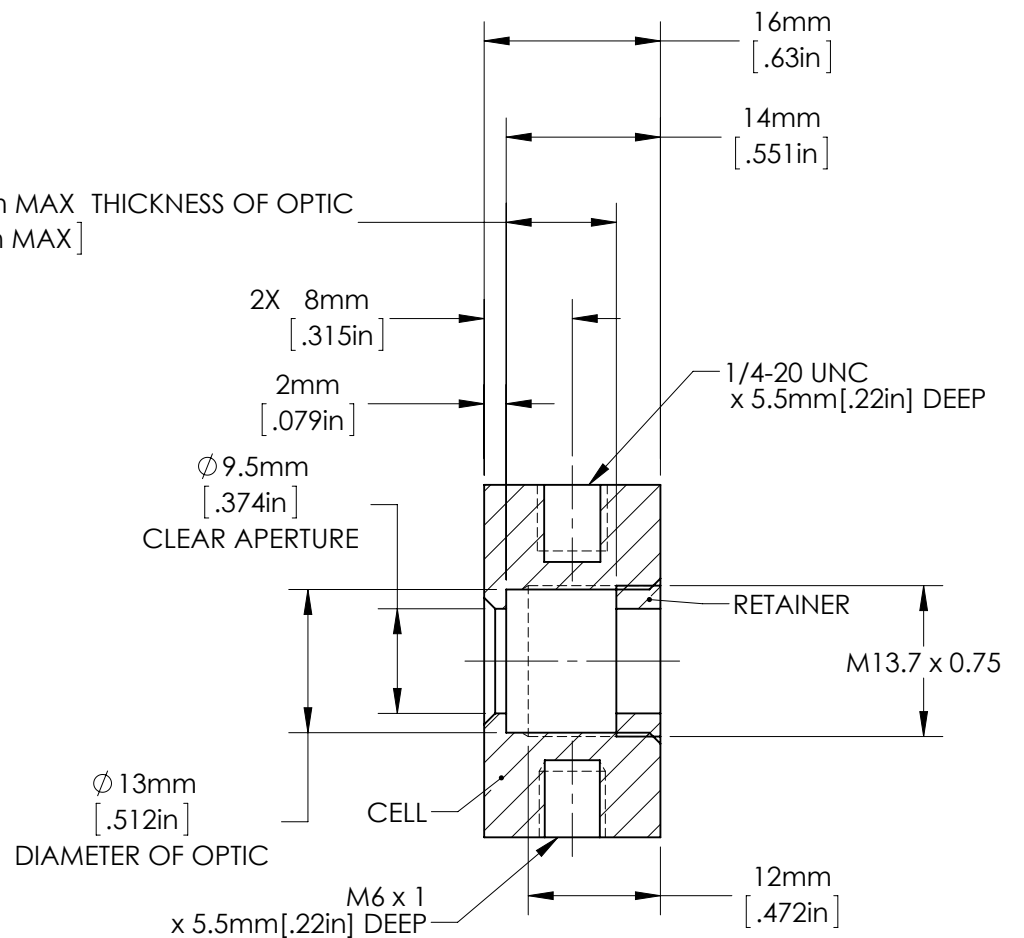

SECTION A-A

**FOR INFORMATION ONLY:
DO NOT MANUFACTURE
PARTS TO THIS DRAWING**

SPECIFICATIONS SUBJECT TO CHANGE WITHOUT NOTICE
DIMENSIONS ARE FOR REFERENCE ONLY
DIMENSIONS ARE IN mm [INCHES]

 Edmund Optics®

TITLE	Optic Mount, 12.7mm Optic Diameter, 10mm Max Optic Thickness		
DWG NO	64556	MATERIAL	BLACK ANODIZED ALUMINUM
			SHEET 1 OF 1