

NOTES:

1. SUBSTRATE:  
GRADE A FINE ANNEALED  
SCHOTT: N-SF11 785/258
2. ROHS COMPLIANT
3. CENTERING TOLERANCE (AT 587.6nm):  
BEAM DEVIATION (HALF ANGLE): <3 ARCMIN
4. COATING (APPLY ACROSS COATING APERTURE)  
S1 & S2: NIR I  
R(AVG) ≤ 0.5% FROM 600-1050nm @ 0° AOI
5. FINE GRIND SURFACE
6. POWER, IRREGULARITY, AND SURFACE QUALITY SPECIFICATIONS APPLY ACROSS CLEAR APERTURE
7. FOCAL LENGTH (EFL): 7.50mm±1%  
BACK FOCAL LENGTH (BFL): 6.10mm
8. PROTECTIVE BEVEL AS NEEDED
9. DESIGN WAVELENGTH: 587.6nm

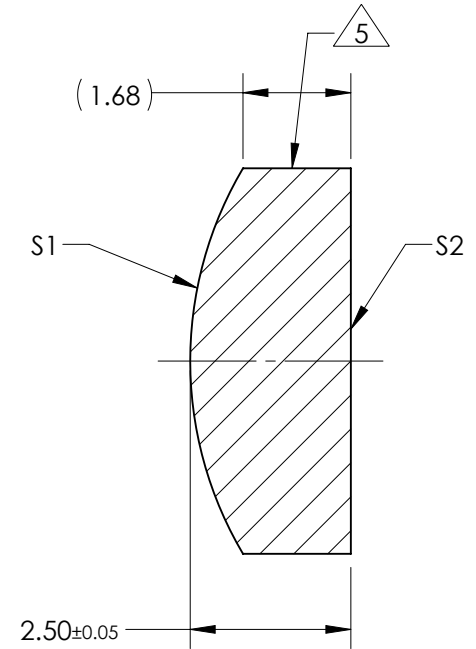
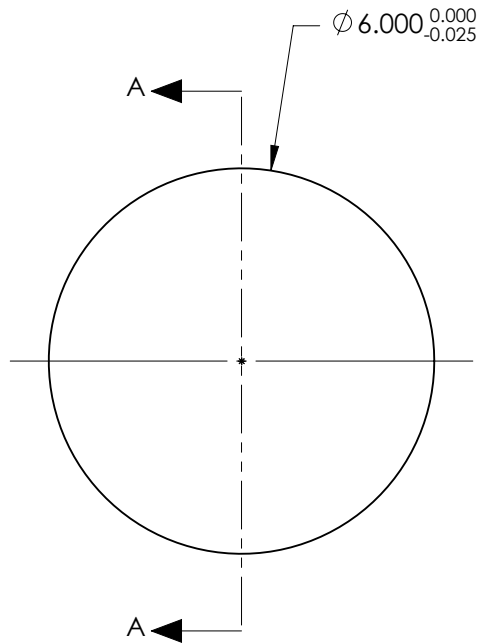

SECTION A-A

**FOR INFORMATION ONLY:  
DO NOT MANUFACTURE  
PARTS TO THIS DRAWING**

|                         | S1         | S2         |
|-------------------------|------------|------------|
| SHAPE                   | CONVEX     | PLANO      |
| RADIUS                  | 5.89       | INFINITY   |
| SURFACE QUALITY         | 40 - 20    | 40 - 20    |
| MIN CLEAR APERTURE      | ∅ 5.40     | ∅ 5.40     |
| MIN COATING APERTURE    | ∅ 5.00     | ∅ 5.00     |
| POWER AT 632.8nm        | 3.00 RINGS | 3.00 RINGS |
| IRREGULARITY AT 632.8nm | 0.50 RINGS | 0.50 RINGS |

SPECIFICATIONS SUBJECT TO CHANGE WITHOUT NOTICE  
DIMENSIONS ARE FOR REFERENCE ONLY

**EO**® Edmund Optics®

|                        |    |        |  |
|------------------------|----|--------|--|
| THIRD ANGLE PROJECTION |    | TITLE  | 6.0mm Dia. x 7.5mm FL, NIR I Coated, Plano-Convex Lens |
| ALL DIMS IN            | mm | DWG NO | 49904  |
|                        |    |        | SHEET 1 OF 1   |