

NOTES:

1. SUBSTRATE:
ELEMENT A: GRADE A FINE ANNEALED
SCHOTT: N-BK7 517/642

ELEMENT B: GRADE A FINE ANNEALED
SCHOTT: N-SF5 673/322
2. ROHS COMPLIANT
3. CENTERING TOLERANCE (AT 587.6nm):
BEAM DEVIATION (HALF ANGLE): <1 ARCMIN
4. COATING (APPLY ACROSS COATING APERTURE)
S1 & S4: VIS 0°
R(AVG) ≤ 0.4% FROM 425-675nm @ 0° AOI
S2 & S3: NONE
5. FINE GRIND SURFACE
6. POWER, IRREGULARITY, AND SURFACE QUALITY SPECIFICATIONS APPLY ACROSS CLEAR APERTURE
7. FOCAL LENGTH (EFL): 200.00mm ±2%
BACK FOCAL LENGTH (BFL): 196.57mm
8. PROTECTIVE BEVEL AS NEEDED
9. DESIGN WAVELENGTH: 587.6nm
10. ELEMENTS TO BE CEMENTED WITH NORLAND OPTICAL ADHESIVE NOA61

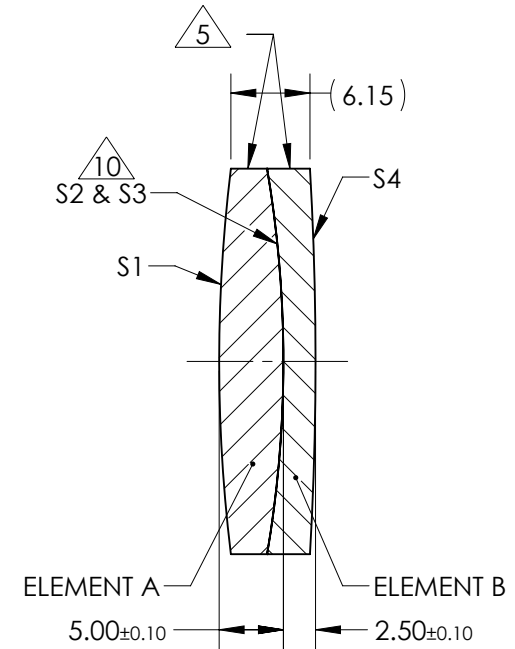
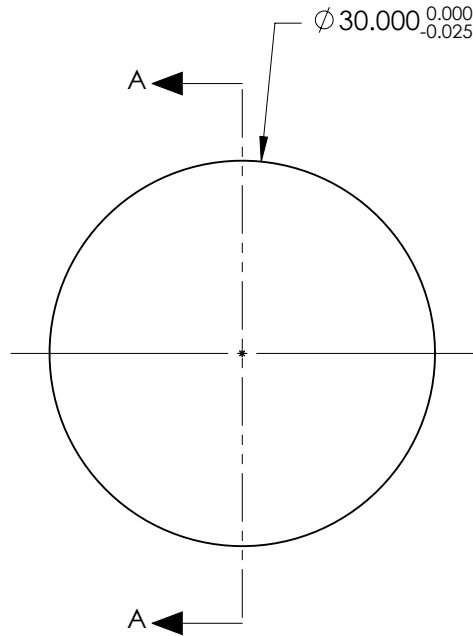

SECTION A-A

**FOR INFORMATION ONLY:
DO NOT MANUFACTURE
PARTS TO THIS DRAWING**

SPECIFICATIONS SUBJECT TO CHANGE WITHOUT NOTICE
DIMENSIONS ARE FOR REFERENCE ONLY

ELEMENT TITLE	SPECIFICATIONS AFTER CEMENTING			
	ELEMENT A		ELEMENT B	
SURFACE	S1	S2	S3	S4
SHAPE	CONVEX	CONVEX	CONCAVE	CONVEX
RADIUS	123.77	89.22	89.22	259.43
SURFACE QUALITY	40 - 20	40 - 20	40 - 20	40 - 20
MIN CLEAR APERTURE	∅ 29.00	∅ 29.00	∅ 29.00	∅ 29.00
MIN COATING APERTURE	∅ 29.00	N/A	N/A	∅ 29.00
POWER AT 632.8nm	3.00 RINGS	3.00 RINGS	3.00 RINGS	3.00 RINGS
IRREGULARITY AT 632.8nm	0.50 RINGS	0.50 RINGS	0.50 RINGS	0.50 RINGS

THIRD ANGLE PROJECTION

ALL DIMS IN mm

EO [®] Edmund Optics [®]

TITLE: 30mm Dia. x 200mm FL, VIS 0 Coated, Achromatic Lens

DWG NO: 47719

SHEET 1 OF 1