

NOTES:

1. ALLOWABLE OPTICAL MATERIAL:
SCHOTT: Fused Silica 458/678
2. SURFACE S2 TO BE PARALLEL WITH SURFACE S1 TO < 3 ARCMIN
3. COATING (APPLY ACROSS COATING APERTURE)

S1: PROTECTED SILVER
 Ravg >98% 500-800nm @ 0° AOI
 Ravg >97% 2,000-10,000nm @ 0° AOI

S2: NONE

4. ARROW ON EDGE POINTING TOWARDS SURFACE S1.

5. FINE GROUND SURFACE

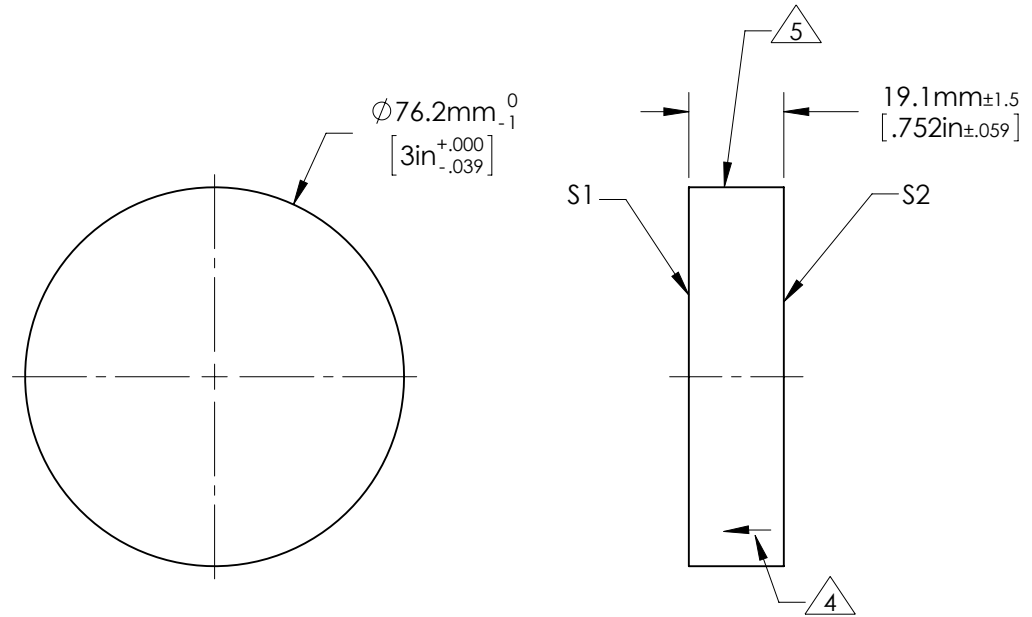

**FOR INFORMATION ONLY:
 DO NOT MANUFACTURE PARTS TO THIS DRAWING**

	S1	S2	EFL (AT 587.6nm)	NA	 Edmund Optics®	
SHAPE	PLANO	PLANO				
SURFACE ACCURACY AT 632.8nm	1/20 WAVE	NA	BFL (AT 587.6nm)	NA	TITLE	1/20λ Optical Flat, Fused Silica, 3inch Diameter PROTECTED SILVER
SURFACE QUALITY	60 - 40	COMMERCIAL POLISH			DWG NO	47573-577
CLEAR APERTURE	∅ 68.6	∅ 68.6				
BEVEL MAX FACE	1.0 x 45°	1.0 x 45°	ALL DIMS IN	mm		