

NOTES:

1. SUBSTRATE:
ELEMENT A: GRADE A FINE ANNEALED
SCHOTT: N-LaK22 651/559

ELEMENT B: GRADE A FINE ANNEALED
SCHOTT: N-SF6 805/254
2. ROHS COMPLIANT
3. CENTERING TOLERANCE (AT 587.6nm):
BEAM DEVIATION (HALF ANGLE): <1 ARCMIN
4. COATING (APPLY ACROSS COATING APERTURE)
S1 & S4: NIR II
R(ABS) ≤ 1.5% FROM 750-800nm @ 0° AOI
R(ABS) ≤ 1.0% FROM 800-1550nm @ 0° AOI
R(AVG) ≤ 0.7% FROM 750-1550nm @ 0° AOI
S2 & S3: NONE
5. FINE GRIND SURFACE
6. POWER, IRREGULARITY, AND SURFACE QUALITY SPECIFICATIONS APPLY ACROSS CLEAR APERTURE
7. FOCAL LENGTH (EFL): 40.00mm ±2%
BACK FOCAL LENGTH (BFL): 37.17mm
8. PROTECTIVE BEVEL AS NEEDED
9. DESIGN WAVELENGTH: 880nm
10. ELEMENTS TO BE CEMENTED WITH NORLAND OPTICAL ADHESIVE NOA61

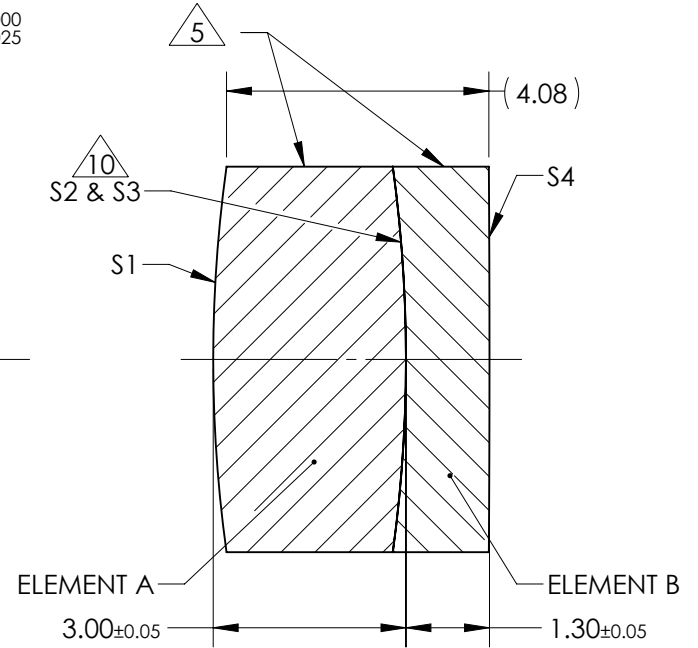
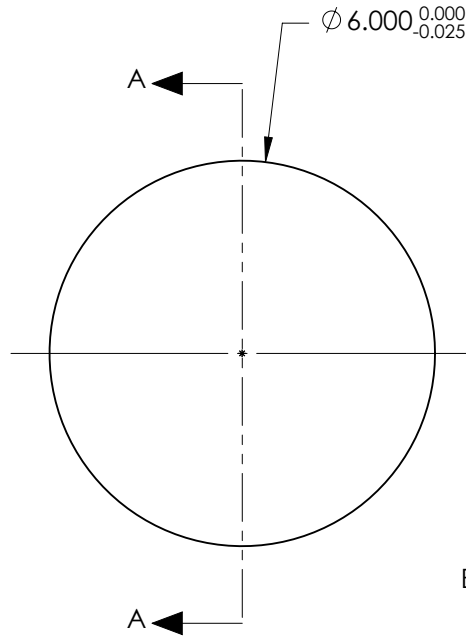

SECTION A-A

**FOR INFORMATION ONLY:
DO NOT MANUFACTURE
PARTS TO THIS DRAWING**

ELEMENT TITLE	SPECIFICATIONS AFTER CEMENTING			
	ELEMENT A		ELEMENT B	
SURFACE	S1	S2	S3	S4
SHAPE	CONVEX	CONVEX	CONCAVE	CONVEX
RADIUS	21.81	22.07	22.07	454.78
SURFACE QUALITY	40 - 20	40 - 20	40 - 20	40 - 20
MIN CLEAR APERTURE	Ø 5.40	Ø 5.40	Ø 5.40	Ø 5.40
MIN COATING APERTURE	Ø 5.00	N/A	N/A	Ø 5.00
POWER AT 632.8nm	3.00 RINGS	3.00 RINGS	3.00 RINGS	3.00 RINGS
IRREGULARITY AT 632.8nm	0.50 RINGS	0.50 RINGS	0.50 RINGS	0.50 RINGS

SPECIFICATIONS SUBJECT TO CHANGE WITHOUT NOTICE
DIMENSIONS ARE FOR REFERENCE ONLY

EO® Edmund Optics®

THIRD ANGLE PROJECTION	TITLE	6mm Dia. x 40mm FL, NIR II Coated, Achromatic Lens	
	ALL DIMS IN	mm	
DWG NO	45790	SHEET	1 OF 1