

NOTES:

1. SUBSTRATE:
GRADE A FINE ANNEALED
SCHOTT: N-BK7 517/642
2. ROHS COMPLIANT
3. CENTERING TOLERANCE (AT 587.6nm):
BEAM DEVIATION (HALF ANGLE): <1 ARCMIN
4. COATING (APPLY ACROSS COATING APERTURE)
S1 & S2: ¼ WAVE MgF2 @ 550nm
R(AVG) < 1.75% FROM 400-700nm (N-BK7)
5. FINE GRIND SURFACE
6. POWER, IRREGULARITY, AND SURFACE QUALITY
SPECIFICATIONS APPLY ACROSS CLEAR APERTURE
7. FOCAL LENGTH (EFL): 50.00mm±1%
BACK FOCAL LENGTH (BFL): 47.82mm
8. PROTECTIVE BEVEL AS NEEDED
9. DESIGN WAVELENGTH: 587.6nm

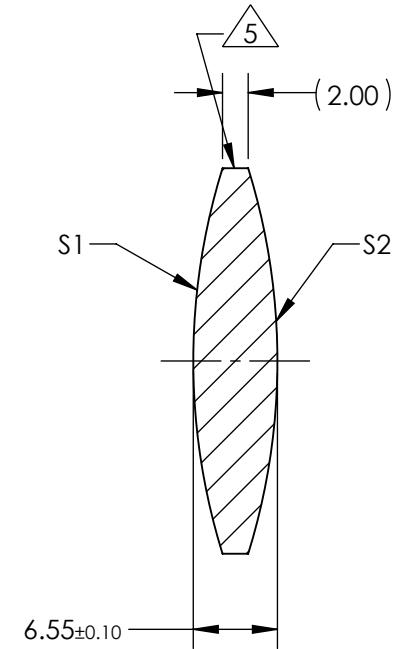
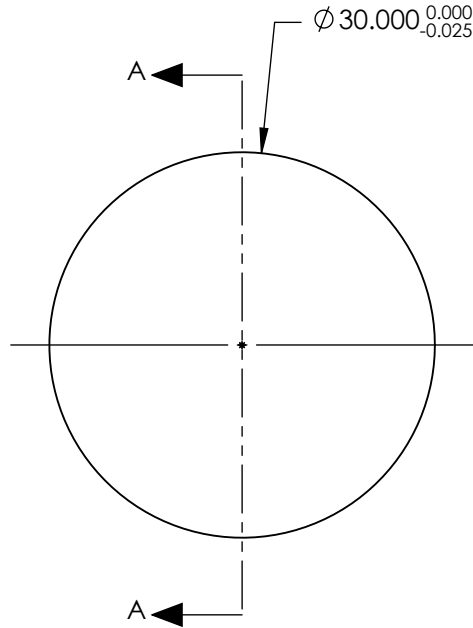

SECTION A-A

**FOR INFORMATION ONLY:
DO NOT MANUFACTURE
PARTS TO THIS DRAWING**

	S1	S2
SHAPE	CONVEX	CONVEX
RADIUS	50.56	50.56
SURFACE QUALITY	40 - 20	40 - 20
MIN CLEAR APERTURE	∅ 29.00	∅ 29.00
MIN COATING APERTURE	∅ 29.00	∅ 29.00
POWER AT 632.8nm	3.00 RINGS	3.00 RINGS
IRREGULARITY AT 632.8nm	0.50 RINGS	0.50 RINGS

SPECIFICATIONS SUBJECT TO CHANGE WITHOUT NOTICE
DIMENSIONS ARE FOR REFERENCE ONLY

EO® Edmund Optics®

THIRD ANGLE PROJECTION		TITLE	30mm Dia. x 50mm FL, MgF2 Coated, Double-Convex Lens
ALL DIMS IN	mm	DWG NO	45164
			SHEET 1 OF 1