

**TECHSPEC® 5mm FL f/8, Rugged Blue Series M12 Lens**

#36-359



5mm FL Rugged Blue Series M12 Lens

TECHSPEC® Rugged Blue Series M12 Lenses have [stabilized ruggedization](#), protecting the lens from damage, while reducing pixel shift and maintaining optical pointing stability after shock and vibration. Each lens consists of several precision glass optics that are glued in place inside a compact, aluminum housing. Gluing the glass optics prevents even the smallest movements that often cause pixel shift. Object to image mapping is maintained even after heavy shock and vibration; if the center of the object maps onto the center pixel, it will always map to that same center pixel. TECHSPEC Rugged Blue Series M12 Lenses are ideal for calibrated imaging applications such as measurement and gauging, 3D stereo vision, robotics and sensing, autonomous vehicles, and object tracking. These lenses are available in a variety of  $f/\#$  options ranging from  $f/2.5$  to  $f/8$ .

Outer Diameter (mm):	14
Wavelength Range (nm):	400 - 700
Type:	M12 Imaging Lens
Back Focal Length BFL (mm):	4.0 - 3.9
IR Cut Filter:	No

## Optical

Horizontal Field of View, 1/3" Sensor:	165.5mm - 57.3°
Maximum Image Circle (mm):	6.00
Numerical Aperture NA, Object Side:	0.0020
Horizontal Field of View @ Max Sensor Format:	165.5mm - 57.3°
Focal Length FL (mm):	5.00
Primary Magnification PMAG:	0.033X
Maximum Sensor Format:	1/3"
Working Distance (mm):	150 - ∞
Aperture (f/#):	f/8
Distortion (%):	-18.88 @ Full Field
Coating Specification:	λ/4 MgF <sub>2</sub> @ 550nm
Entrance Pupil Position (mm):	2.74
Horizontal Field of View, 1/4" Sensor:	117.5mm - 42.3°
Object Space Principal Plane (mm):	5.94
Image Space Principal Plane (mm):	2.53
Field of View at Max Sensor Format:	Horizontal: 165.7mm - 57.3° Vertical: 117.5mm - 42.3° Diagonal: 225.4mm - 73.4°
Exit Pupil Position (mm):	-6.51
Lens Wavelength Range:	VIS

## Mechanical

Length (mm):	14.60
Maximum Diameter (mm):	14
Weight (g):	4
Number of Elements (Groups):	6(5)
Mount:	M12 x 0.5 (S-Mount)

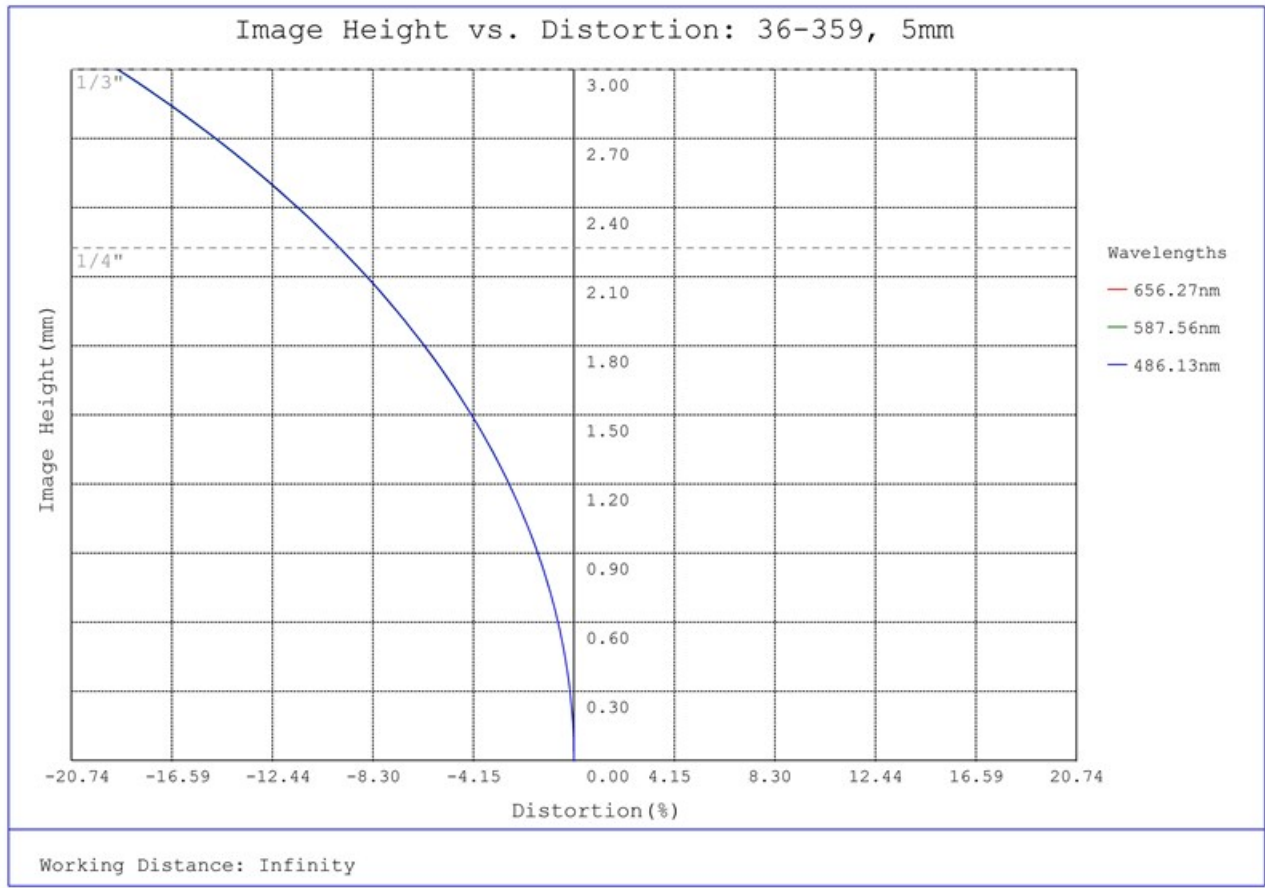

#36-359, 5mm FL f/8, Rugged Blue Series M12 Lens, Distortion Plot

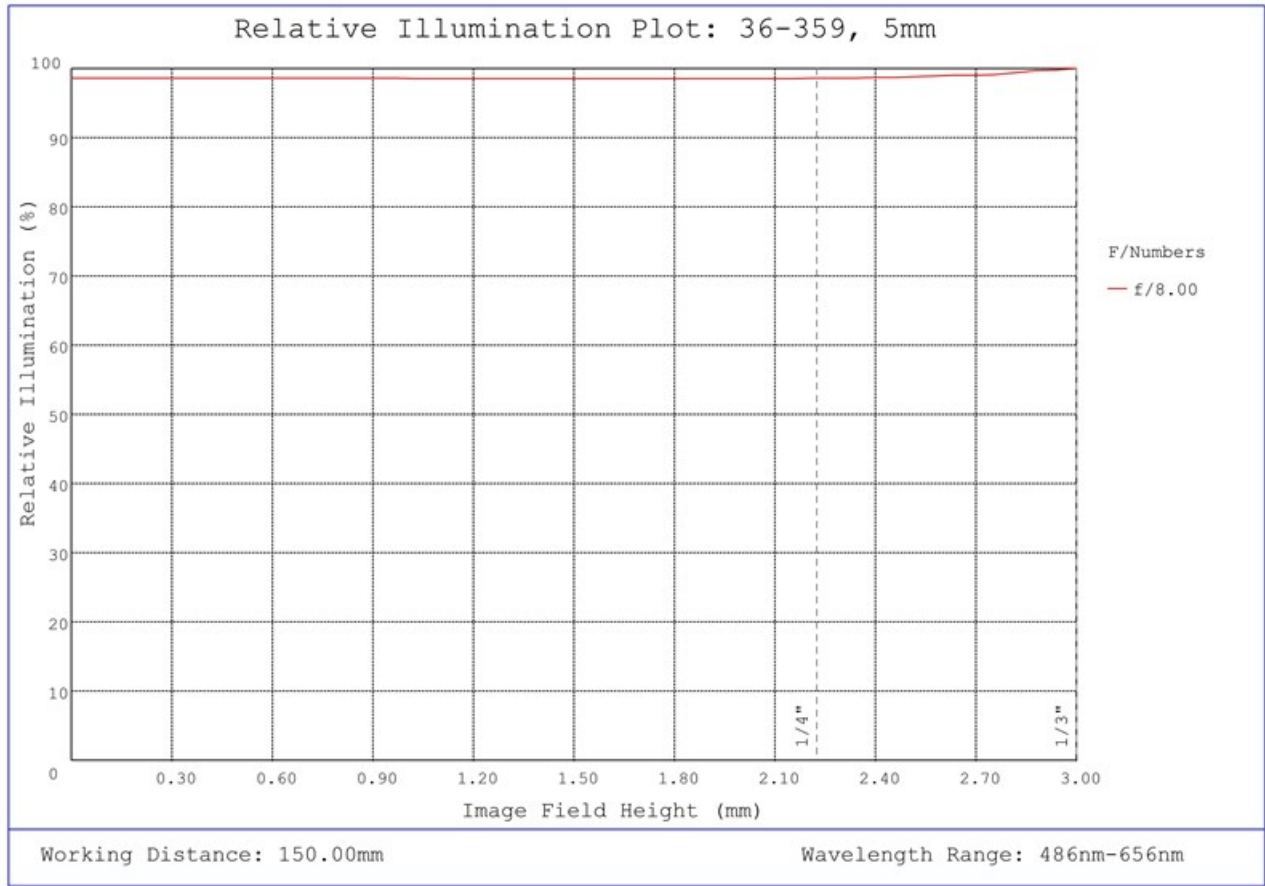

#36-359, 5mm FL f/8, Rugged Blue Series M12 Lens, Relative Illumination Plot

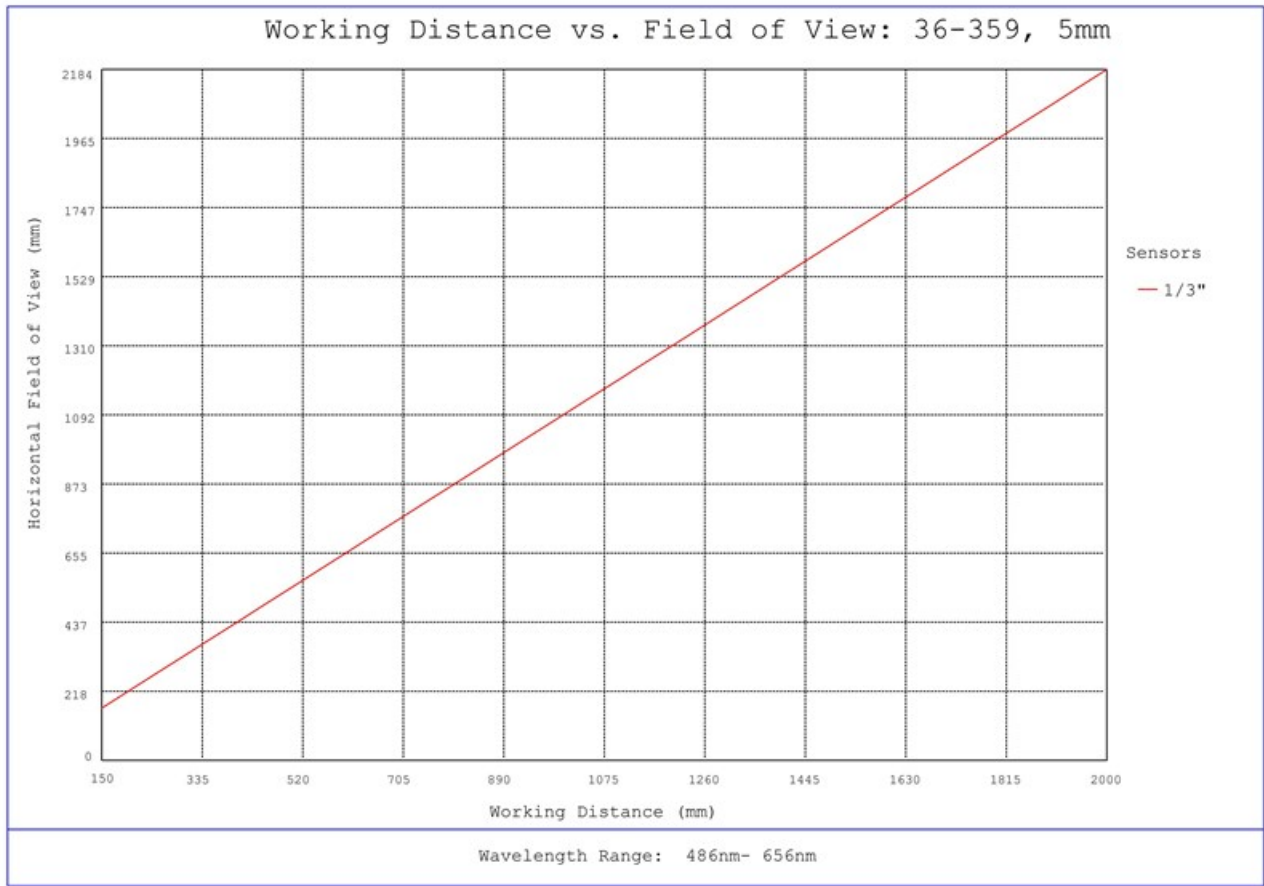

#36-359, 5mm FL f/8, Rugged Blue Series M12 Lens, Working Distance versus Field of View Plot

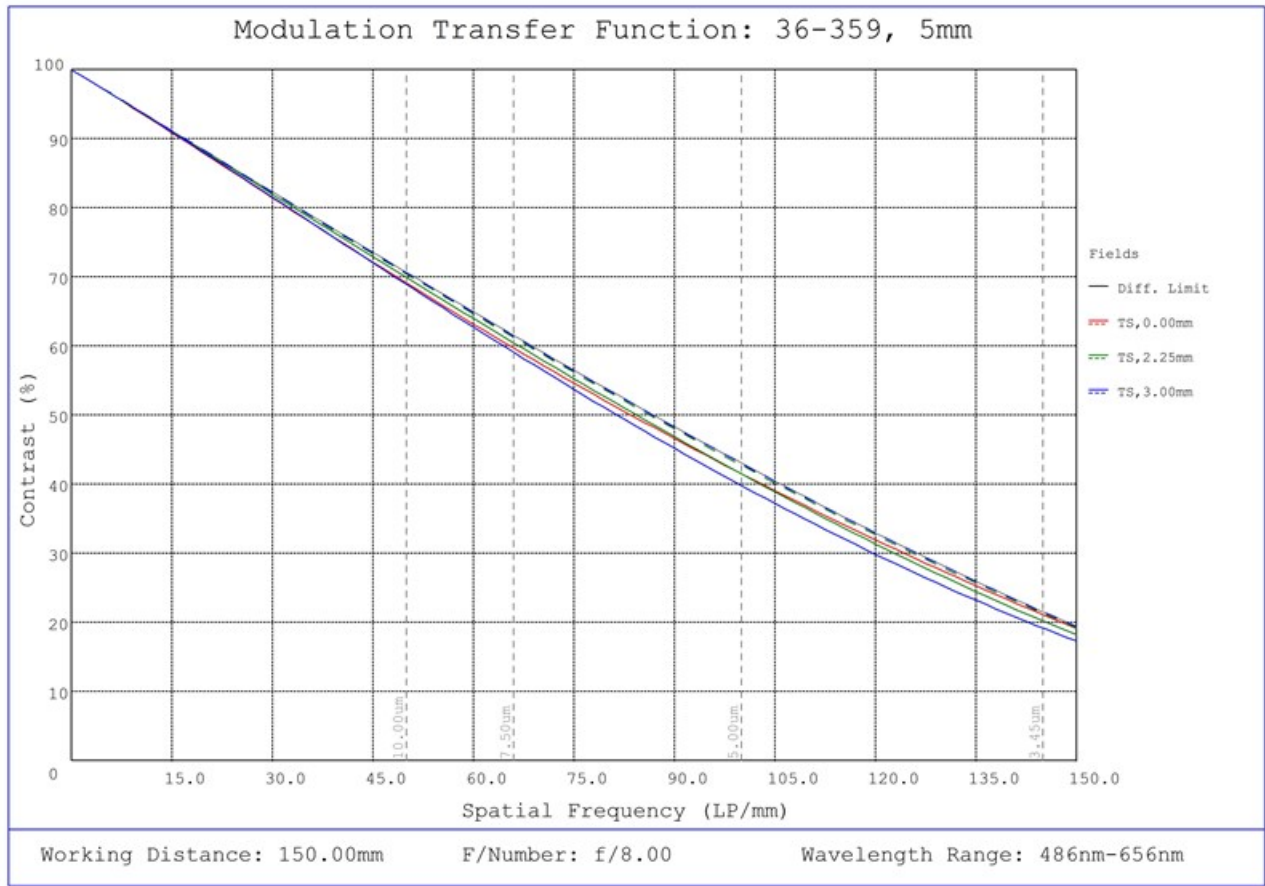

#36-359, 5mm FL f/8, Rugged Blue Series M12 Lens, Modulated Transfer Function (MTF) Plot, 150mm Working Distance, f8

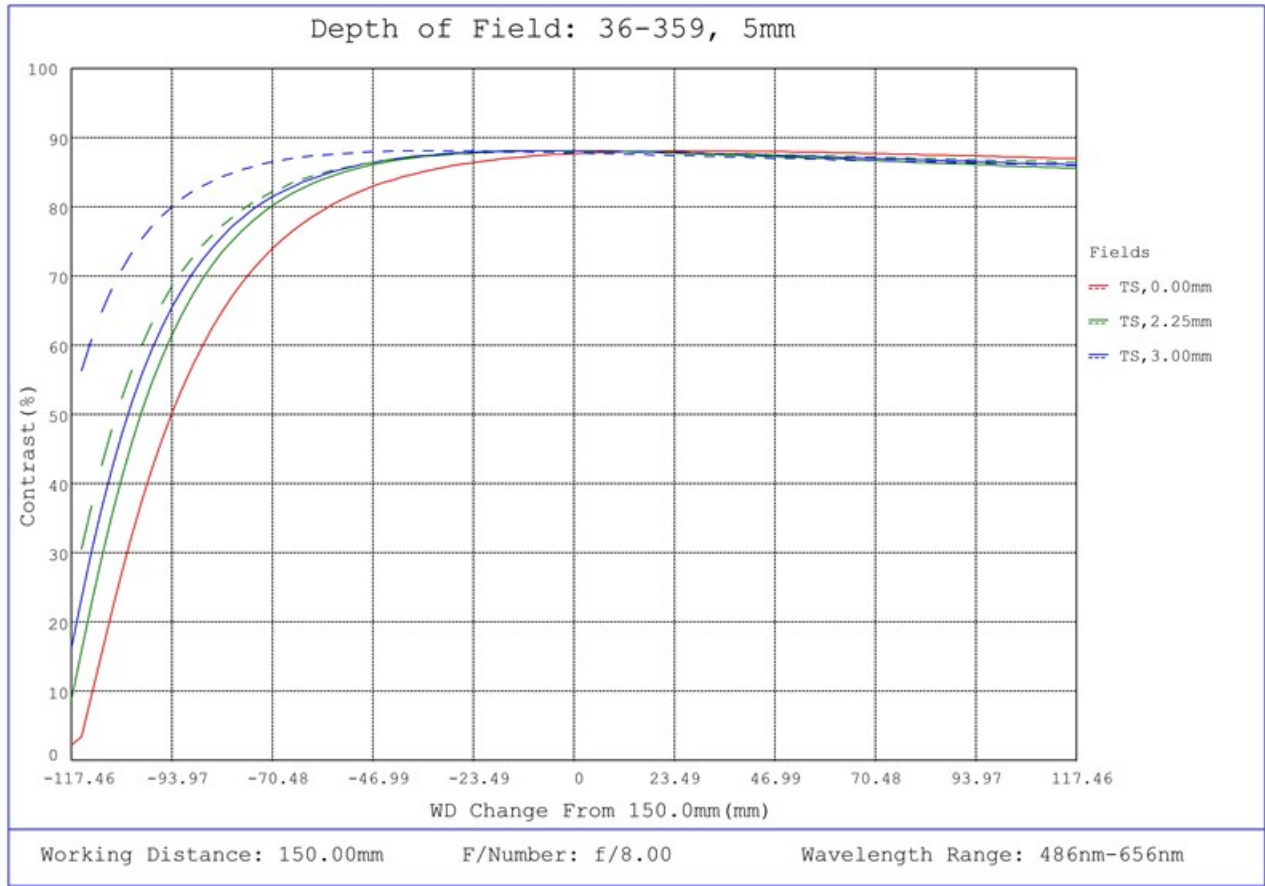

#36-359, 5mm FL f/8, Rugged Blue Series M12 Lens, Depth of Field Plot, 150mm Working Distance, f8

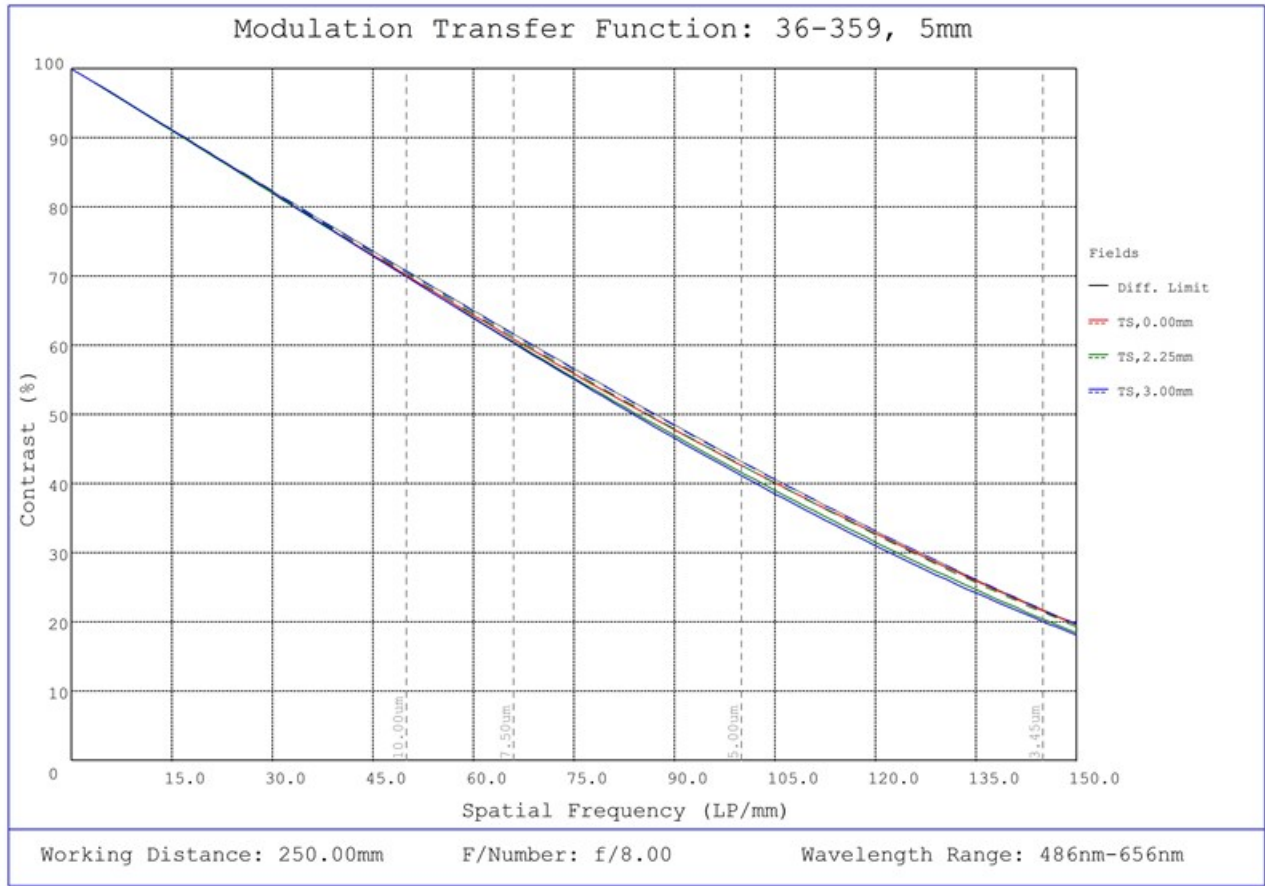

#36-359, 5mm FL f/8, Rugged Blue Series M12 Lens, Modulated Transfer Function (MTF) Plot, 250mm Working Distance, f8



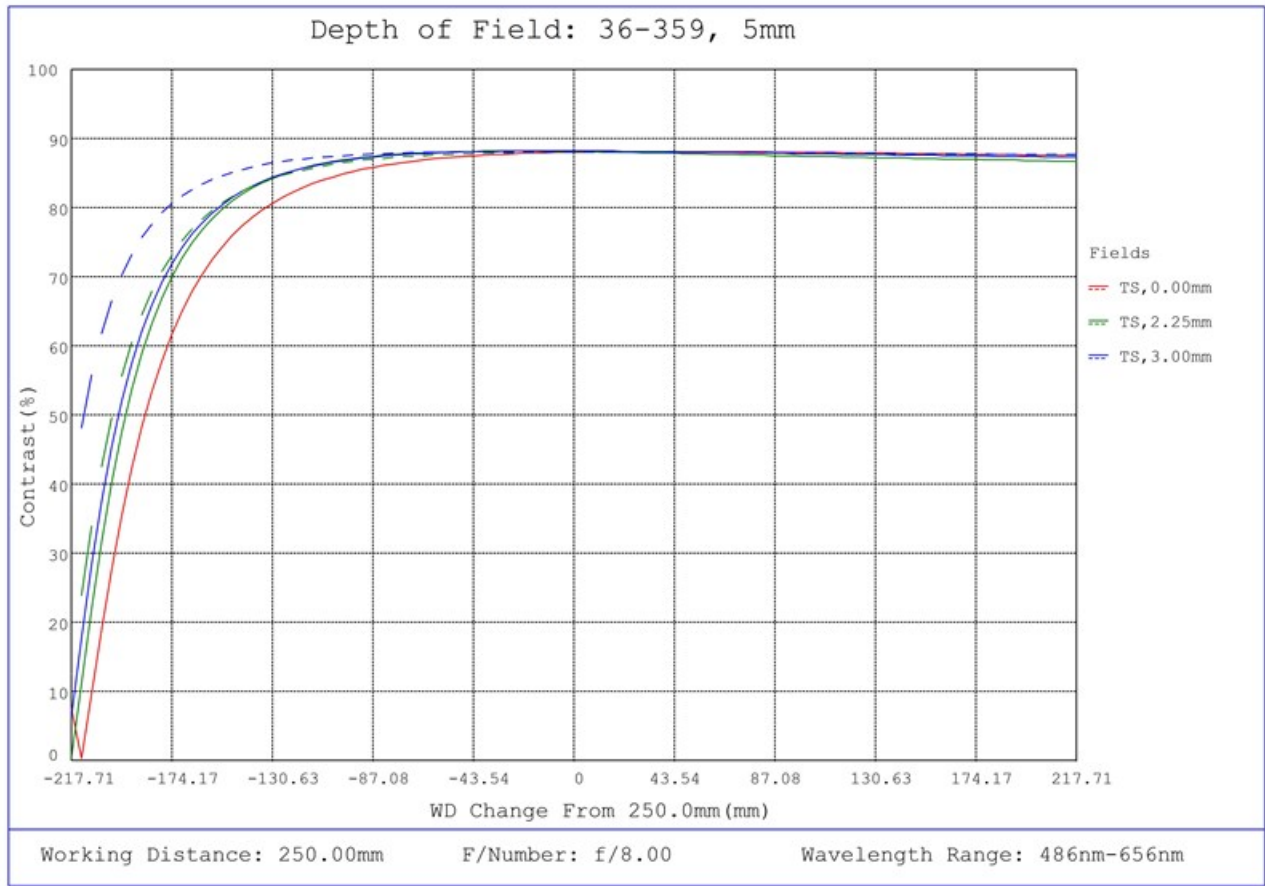

#36-359, 5mm FL f/8, Rugged Blue Series M12 Lens, Depth of Field Plot, 250mm Working Distance, f8

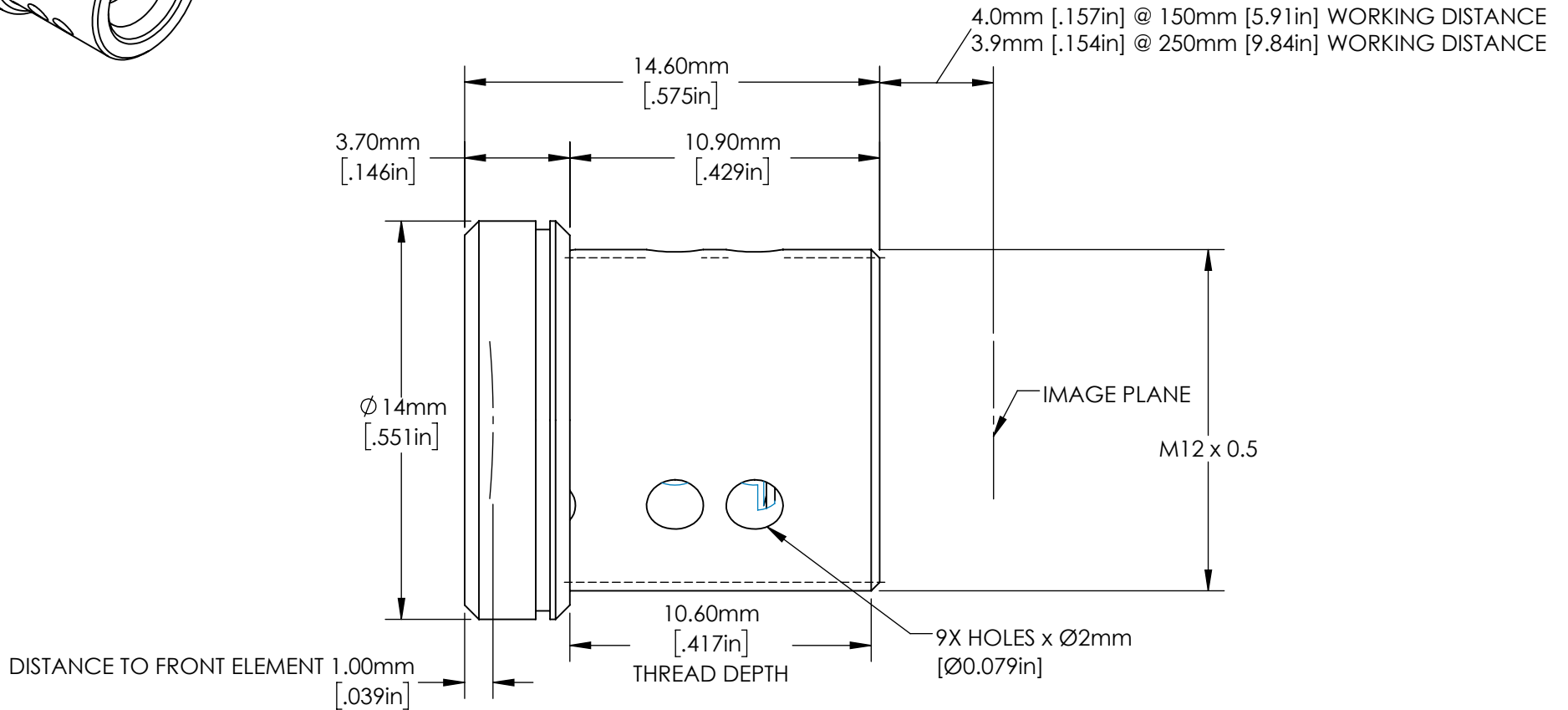
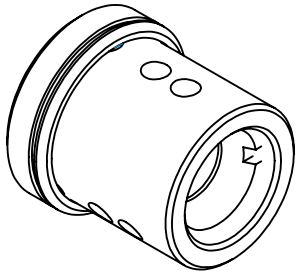

**FOR INFORMATION ONLY:  
DO NOT MANUFACTURE  
PARTS TO THIS DRAWING**

SPECIFICATIONS SUBJECT TO CHANGE WITHOUT NOTICE DIMENSIONS ARE FOR REFERENCE ONLY. FOR DETAILED SPECIFICATIONS, PLEASE REFER TO THE SPEC SHEET.

**EO**® Edmund Optics®

THIRD ANGLE PROJECTION		TITLE	5mm FL, F8.0 RUGGED BLUE M12	
ALL DIMS IN	mm / [in]	DWG NO	36359	SHEET 1 OF 1



June 07, 2023

To Whom It May Concern,

This document certifies that the product stated below has been reviewed as requested by Edmund Optics:

<i>Stock No.</i>	<i>Description</i>
36-359	5mm FL f/8, Rugged Blue Series M12 Lens

This item is EU RoHS (2011/65/EU) compliant without the use of exemptions.

This certification means that:

- EO's suppliers have confirmed the material composition of this product.
- EO has implemented rigorous procedures to document this compliance.
- The information provided may, or may not, be based upon actual test data, or on information from our Vendors, Raw Material Suppliers or Subcontractors.

A handwritten signature in cursive script, appearing to read 'Jay Budd'.

Jay Budd, Director of Corporate Compliance

June 07, 2023

Edmund Optics Inc. - 101 E Gloucester Pike, Barrington, NJ 08007 | 1-800-363-1992 | [Compliance@edmundoptics.com](mailto:Compliance@edmundoptics.com)



June 07, 2023

<i>Stock No.</i>	<i>Description</i>
36-359	5mm FL f/8, Rugged Blue Series M12 Lens

Edmund Optics certifies that all articles included in this shipment are in compliance with the terms and conditions of this order. The company also certifies that the articles included in this shipment are in accordance to all agreed upon specifications and quality assurance provisions. Please call 1-800-363-1992 should any questions arise from this shipment.

A handwritten signature in black ink, appearing to read 'Jeff Harvey'.

Jeff Harvey- EVP of Operations